

~~TOP SECRET~~



HANDLE VIA

CONTROL SYSTEM ONLY

CORONA Program History

Volume V System Integration

**DIRECTORATE OF SCIENCE AND TECHNOLOGY
CENTRAL INTELLIGENCE AGENCY**

Declassified and Released by the N R O

in Accordance with E. O. 12958

on

NOV 4 6 1991

~~TOP SECRET~~

Exempt from general declassification
Schedule of Executive Order 11652
Exemption category [ss 5B(2)]
Automatically declassified on
IMPOSSIBLE TO DETERMINE.

104

~~Warning~~

~~This document contains information affecting the national security of the United States within the meaning of the espionage laws U.S. Code Title 18, Sections 793 and 794. The law prohibits its transmission or the revelation of its contents in any manner to an unauthorized person, as well as its use in any manner prejudicial to the safety or interest of the United States or for the benefit of any foreign government to the detriment of the United States. It is to be seen only by U. S. personnel especially indoctrinated and authorized to receive information in the designated control channels. Its security must be maintained in accordance with regulations pertaining to the designated controls.~~

Published By

HQ AIR FORCE SPECIAL PROJECTS PRODUCTION FACILITY

~~TOP SECRET~~

CORONA HISTORY
Volume V

CORONA PROGRAM HISTORY

VOLUME V



SYSTEM INTEGRATION

19 May 1976

This volume consists of 103 pages.

Volume V of V Volumes

~~TOP SECRET~~

Handle via 
Controls Only

CORONA HISTORY
Volume V

PUBLICATION REVIEW

This report has been reviewed and is approved.



CORONA Project Officer
Directorate of Science & Technology
Central Intelligence Agency

CORONA HISTORY
Volume V

TABLE OF CONTENTS

	Page
TITLE PAGE	i
PUBLICATION REVIEW	ii
TABLE OF CONTENTS	iii
DISTRIBUTION	iv
SECTION I - INTEGRATING CONTRACTOR AND DEVELOPMENT OF THE SYSTEM	1-1
SECTION II - EVOLUTION OF THE CAMERA SYSTEMS	2-1
SECTION III - SECURITY AND FACILITIES	3-1
SECTION IV - THE AGENA VEHICLE AND THE THOR BOOSTER	4-1
SECTION V - CORONA OPERATIONS	5-1

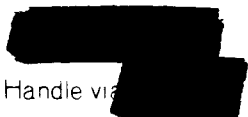
Handle via 
Controls Only

DISTRIBUTION

<u>Organization</u>	<u>For Attention of</u>	<u>Copy Number</u>
[REDACTED]	[REDACTED]	[REDACTED]
[REDACTED]	[REDACTED]	[REDACTED]
[REDACTED]	[REDACTED]	[REDACTED]
[REDACTED]	[REDACTED]	[REDACTED]
[REDACTED]	[REDACTED]	[REDACTED]
[REDACTED]	[REDACTED]	[REDACTED]
[REDACTED]	[REDACTED]	[REDACTED]
[REDACTED]	[REDACTED]	[REDACTED]
[REDACTED]	[REDACTED]	[REDACTED]
[REDACTED]	[REDACTED]	[REDACTED]
[REDACTED]	[REDACTED]	[REDACTED]
[REDACTED]	[REDACTED]	[REDACTED]
[REDACTED]	[REDACTED]	[REDACTED]
[REDACTED]	[REDACTED]	[REDACTED]
[REDACTED]	[REDACTED]	[REDACTED]
[REDACTED]	[REDACTED]	[REDACTED]
[REDACTED]	[REDACTED]	[REDACTED]
[REDACTED]	[REDACTED]	[REDACTED]
[REDACTED]	[REDACTED]	[REDACTED]
[REDACTED]	[REDACTED]	[REDACTED]
[REDACTED]	[REDACTED]	[REDACTED]

INTEGRATING CONTRACTOR
AND
DEVELOPMENT OF THE SYSTEM

~~TOP SECRET~~

CORONA HISTORY
Volume V

SECTION I

INTEGRATING CONTRACTOR AND DEVELOPMENT OF THE SYSTEM

In the early 1950s the Rand Corporation published a series of studies covering the feasibility and utility of satellite vehicles. In 1955, as a result of these studies, the WS-117L Program Office was established, and a one year competitive study for the preliminary design of an earth orbiting satellite was initiated. Lockheed was the winner of this study. Starting in October 1956, Lockheed continued investigation and research efforts on the development of space systems. This work was labeled "Project 97" and was funded at a low level. However, with the Russian launching of their first Sputnik satellite in October 1957, the funding emphasis changed. By early 1958, funding became available for a concentrated effort to develop a US military space capability. As a result and as early as December 1958, the AGENA satellite became a reality.

When the decision was made to place one of the WS-117L photographic subsystems under covert management, the Lockheed Missile and Space Company (LMSC), then a division of Lockheed Aircraft Corporation, was selected as a prime contractor. This company was selected by the Advanced Research Projects Agency (ARPA) and the CIA. The subcontractors to LMSC were Itek for the camera and the Space Re-entry Program Division of General Electric for the recovery system. Lockheed was to supply the satellite vehicle (AGENA) and the photographic payload system and was responsible for the command and control of the satellite during launch and orbital operations. The early Lockheed contracts also included responsibilities for the launch and tracking selection, test hardware, and vehicle integration. In addition to the THOR booster and the development of the AGENA, the launch facilities, tracking stations, and communications were identified, the sites constructed, and equipment installed in a period of 10 months. These achievements allowed for a launch attempt in December 1958.

It was determined by the Program Office that all reconnaissance operations were to be developed in a covert facility. [REDACTED]

[REDACTED] At that time the scheduled life of the program was to be one year. This program was named CORONA. It became the longest continuous space program ever conducted by the United States. The CORONA contract also included provisions for tools, manufacturing space, and support personnel. In addition to the personnel assigned by [REDACTED] Lockheed provided management and technical specialists to the facility to set up an integrated and autonomous organization designated the Advanced Projects (AP) Division [REDACTED]

From this small group of about 30 people from Lockheed [REDACTED] the program grew to a peak of over

~~TOP SECRET~~

CORONA HISTORY
Volume V

400 in 1963 when the MURAL, LANYARD, ARGON, and J-1 payloads were in production. The number of employees gradually decreased until the final launch in May 1972 when about 50 Lockheed personnel were left assigned to [REDACTED] (the last designator for Project CORONA).

The AP Facility started in 1958 with approximately 3,100 square feet of leased space, grew to nearly 78,000 square feet by 1965, and ultimately became the central point for the photographic payload system technical direction, final assembly, and test and software preparation for command and control. There was also a period when the orbital timer for the AGENA was received and prepared for launch at this building because of the covert nature of the vehicle commands being punched into the memory tape.

The CORONA Program was unique among space programs within Lockheed in that the full integration of the space vehicle and its many payloads were the responsibility of the Program Office. This included technical (mechanical, electrical, environmental, etc.), mission planning, launch, and orbital support.

Mr. James W. Plummer was placed in charge of the original organization of management and technical personnel who manned the [REDACTED]. He also managed the Lockheed AGENA and the biomedical program series called DISCOVERER. Mr. Plummer reported to Lockheed management through [REDACTED] and [REDACTED] to Willis Hawkins, then Assistant General Manager. Assisting Mr. Plummer at the [REDACTED] were [REDACTED] Administration and Controls; [REDACTED] Operations; [REDACTED] Research and Electrical Design; and [REDACTED] Mechanical Design and Fabrication. [REDACTED] became AP Manager in the 1961 - 1964 period; [REDACTED] from 1964 - 1967; [REDACTED] from 1967 - 1971; and [REDACTED] from 1971 - 1972. Figure 1-1 presents a picture of the AP managers.

The AGENA satellite vehicle was produced in the Lockheed plant at Sunnyvale, California. In addition, the well publicized biomedical recovery system was controlled in Sunnyvale since this capsule was part of the cover story for the photographic capsule. Administratively, the Advanced Engineering Test (AET) organization at the [REDACTED] plant reported to the AGENA office in Sunnyvale. Some years later, the AET title was dropped and the organization was called Advanced Projects, or simply AP.

The DISCOVERER Program Office and its successor organizations were headed by James Plummer from 1958 to 1961; [REDACTED] 1961 to 1966; [REDACTED] 1966 to 1968; [REDACTED] 1968 to 1969; [REDACTED] 1969 to 1971; and [REDACTED] 1971 to 1972. Figure 1-2 presents a picture of the DISCOVERER Program managers from Lockheed.

The success of any program depends upon the people employed and the atmosphere/conditions surrounding

ADVANCED PROJECTS MANAGERS



J. W. Plummer
(1958 - 1961)



(1961 - 1964)



(1964 - 1967)

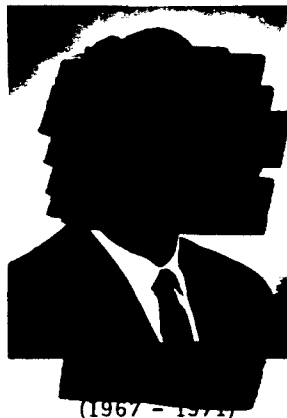

(1967 - 1971)



(1971 - 1972)

Figure 1-1

DISCOVERER PROGRAM MANAGERS



J. W. Plummer
(1958 - 1961)



(1961 - 1966)



(1966 - 1968)



(1968 - 1969)



(1969 - 1971)



(1971 - 1972)

Figure 1-2

CORONA HISTORY
Volume V

it. The CORONA Program was no exception. The covert environment of the program required that access be rigidly limited for all organizations, Government as well as contractors. The added advantages of this closed environment were highly motivated personnel, rapid and direct communications, and less unproductive interference. Although the facility was managed by Lockheed, its organization included permanent Government technical representatives, the [redacted] work force, and the Itek, Fairchild, and General Electric field crews. In addition, the location of management and technical support was conveniently situated. The DISCOVERER Program Office in Sunnyvale, Lockheed Palo Alto Research Laboratories, Itek West Coast Office, and other subcontractors were for the most part close by.

Communication links to Itek in Boston, Fairchild in New York, General Electric in Philadelphia, Eastman Kodak in Rochester, and to Government agencies in Washington DC and Los Angeles were available 24 hours a day through special telephones and TWX lines. The problems which arose varied in magnitude over the years and existed from the start of the program to the final launch; however, in each case the lines of communication established early in the program were maintained and utilized to the final recovery. Rapid and direct communication was a major contributor to the success of the CORONA Program.

In the beginning, no one was exactly sure how the task of reconnaissance from a satellite was to be accomplished. Since this was one of the pioneer efforts there were no "experts" in this field. However, as the result of the many achievements of CORONA, other programs that followed drew heavily upon the experience and knowledge in designing, launching, and recovering satellite vehicles gained through the development of the CORONA Program.

The chief Systems Engineers were [redacted]

[redacted] During the 1957 to 1960 time period, the program was directed by the Program Managers as an integrated organization. In 1960, Lockheed divided its management personnel by project and the first Program Engineering Manager (PEM) was assigned. The PEMs, in order, were [redacted]

The program reached a peak of effort and size during the 1962 - 1963 time period when there were three active contracts in the Program Office. Combined effort in support of these three contracts resulted in the following meaningful statistics: (1) utilized approximately 1,100 personnel (or equivalent) per month, (2) attained three launches in one month, and (3) achieved/supported 22 launches in one year.

The final CORONA space operation (Mission 1117) occurred with the launch of AGENA Vehicle 1663 on 25 May 1972, and on 31 May 1972, at 1345 PDT, Aircraft Number 1 made an air recovery of Re-entry Vehicle

CORONA HISTORY
Volume V

Number 2. Figure 1-3 presents a picture of the last CORONA vehicle (CR-8) on the launch pad. So after 13 years and 3 months (145 AGENA satellite vehicles and 141 CORONA reconnaissance payloads), the era of the first earth satellite photographic reconnaissance system came to an end.

Throughout its history the CORONA Program had several cover identifiers. Known for some time as the "DISCOVERER" Program, it also had a series of numerical designators assigned by the Air Force; i.e., WS-117L, [REDACTED] and a number of internal Lockheed designators; i.e., WS-117L, DISCOVERER, [REDACTED]

Lockheed, as prime contractor and integrator, was involved in all phases of the payload system from camera and recovery system development to on-orbit command and control, and thermal control. Structures for the payload system were fabricated in Sunnyvale which were similar to those structures being fabricated for the biomedical payloads. The photographic payload structures were then diverted undercover to the AP Facility for modifications. These modifications consisted of camera mounts, blow off doors that covered the camera lens through ascent, and associated features required for the camera subsystems. Electrical design and fabrication were accomplished either at the [REDACTED] facility or under subcontract.

As the AP Facility expanded, operating organizations were structured into functions with Design Engineering, Manufacturing, Logistics, and Associate and Subcontractor Offices within close proximity so that the responsible engineers could be quickly available when problems arose in any of the manufacturing/test cycles. Test data and mission analysis, with its supporting computer for command and control, were also located in the AP Facility.

No formal quality assurance (QA) program existed during the early days at AP; however each person was constantly briefed on the importance of his individual responsibility toward QA. The first formal QA program was established in 1961, and as the systems developed, the procedures for quality controlling operations were formalized into standard specifications.

The Advanced Research Facility [REDACTED] was a "U"-shaped office building [REDACTED] with an area of approximately 3,100 square feet. The program continued to operate in this environment until early in 1962 when construction was started on what was to become [REDACTED]. After completion in July 1962, the CORONA offices, manufacturing and test area, and clean room facilities were moved into this new building which was located directly adjacent to [REDACTED]. The next major construction came in mid-1964 when [REDACTED] was started in the same secured complex as [REDACTED]. [REDACTED] included a "Butler" building that housed the stores and transportation/maintenance facilities. Under the project category structure, the Program II ("A" system) engineering and test offices, as

MISSION 1117, THE LAST CORONA FLIGHT

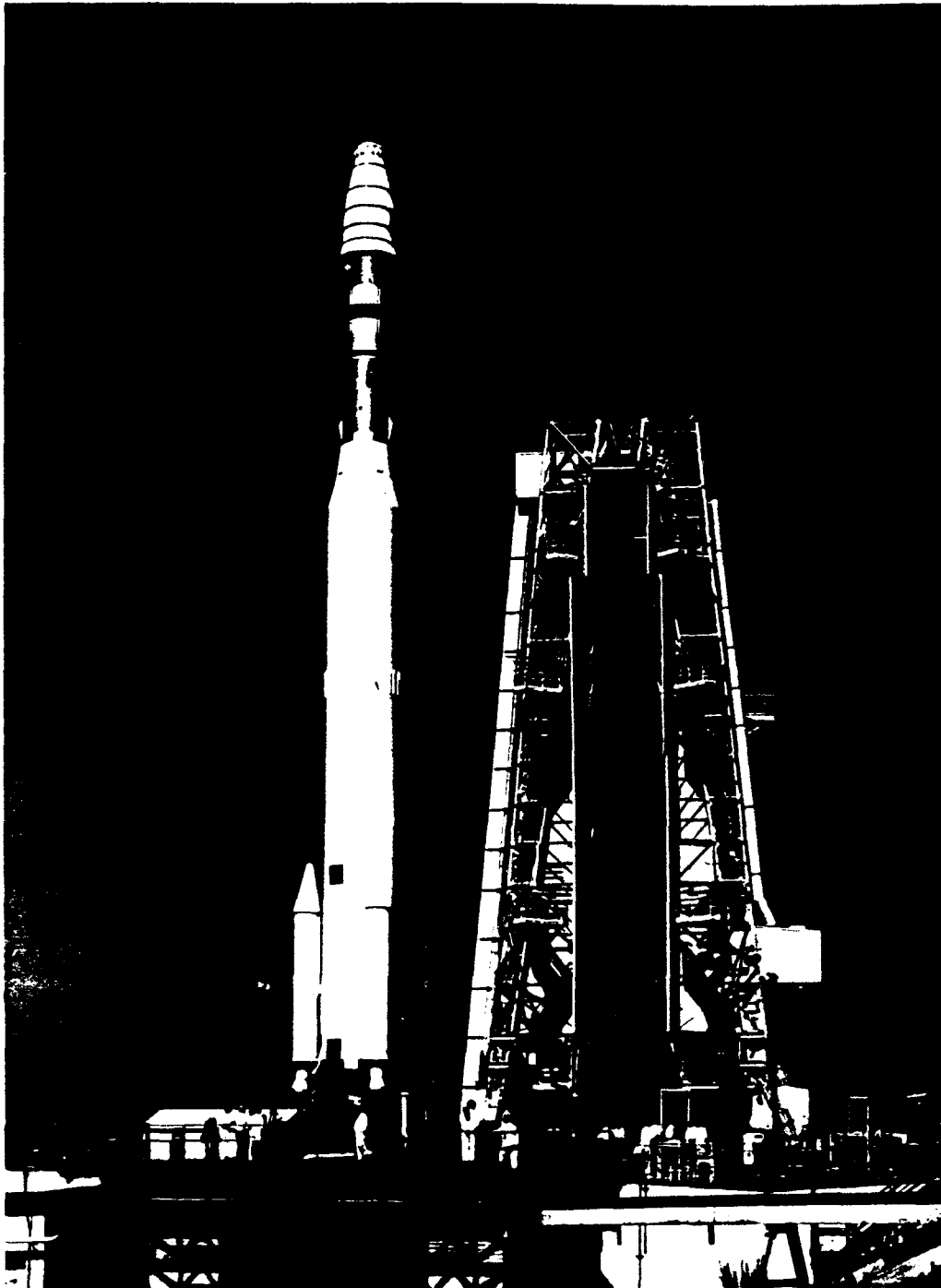

Figure 1-3

CORONA HISTORY
Volume V

well as procurement personnel, were located in these new buildings. The J-1 manufacturing facilities were located on the main floor of [REDACTED]. In August 1964, the "A" program was terminated and the organizations realigned. In October 1964, the engineering, procurement, and manufacturing organizations were located in [REDACTED]. The test, integration, reproduction, and associate offices were located in [REDACTED]. The program, customer, finance, security offices, and the flight readiness clean rooms were located in [REDACTED].

In parallel with the AP Facility, a building at the old Army tank overhaul facility at Vandenberg Air Force Base (VAFB) was rehabilitated for final load and assembly of the payload system before launch. This building was one of several occupied by Lockheed personnel at VAFB in support of AGENA launches. It was modified to include a dark room for loading the system with flight film, a movable collimator, a small processing facility, machines for weight and balance of the recovery capsule, and a sandbagged area for final pyro loading. A small crew of cleared VAFB personnel manned the building to assist AP people in readying the payload for flight.

Final checkout of the AGENA was accomplished in the Missile Assembly building adjacent to the AP building. Since the AGENA was the on-orbit stable platform for the payload, as well as the second-stage boost vehicle, many of the functions necessary to make the photographic system work were available. The AGENA carried the batteries, command control system, and telemetry, as well as the guidance. Because of the many wires crossing the interfaces, a compatibility test of the two systems was required before each launch. These tests were conducted in the Missile Assembly building with the payload enclosed in a small structure or "doghouse" to keep its true purpose covert. Some of the AGENA personnel were cleared to work on payload function testing, and in fact many problems arising from these tests were solved by AGENA and payload personnel working together as a team. It turned out that because of their knowledge that these VAFB launch crews had as much to say about how things were accomplished during the flight preparations as the designers at Sunnyvale and AP.

Because of the unknowns of space environment in the 1958 - 1959 era, a comprehensive test program was initiated. The [REDACTED] AP facilities were completely equipped with a modern manufacturing setup and engineering laboratory to support component and subassembly fabrication/testing and environmental testing equipment and optical collimation facilities for system level testing. The [REDACTED] facilities were designed to handle all but a few exceptional situations. These were the thermal/altitude testing chamber for the complete system and the manufacturing of major structures. These operations were performed at Lockheed's Sunnyvale plant.

CORONA HISTORY
Volume V

The evaluation/analysis data from tests and early flights resulted in many design and manufacturing changes as the systems were being produced. The environment of the covert facility allowed scientists, engineers, and technicians the freedom to develop new ideas, new methods of production, and to incorporate rapid modifications not possible in large manufacturing plants. Ideas from technicians, bench assemblers, or mechanics came as frequently as from the designers. This spirit motivated true teamwork rather than individual effort.

The history and records of the first actual launch were deleted a long time ago as the attempt ended in failure. A timer malfunctioned and the separation rockets, which at that time were attached to the aft rack of the AGENA, ignited before the THOR-AGENA lifted off the pad. An approximate "six inch apogee" was achieved and although still on the pad, the AGENA required major repairs and considerable redesign before again becoming operational. Officially, the first CORONA/AGENA launch occurred on 28 February 1959 when it was announced that the United States Air Force launched Vehicle 1022, the first of a new series of spacecraft intended to provide an orbiting vehicle with three-axis stability (earth-oriented) and the capability of ejecting a recovery capsule and returning it to earth.

Systematic testing, which today is routine on most space programs, originated with CORONA. Since high reliability components were not available early in the program, the philosophy was to test/debug at the component level, then test/debug again at the black box level, once more at the subsystem level, and finally at the system level. There were many problems of a major nature at the system level even after resolving minor component problems. With these phase testing operations, the system level testing was greatly simplified. The overall system reliability was significantly improved as experience was gained through the years as evidenced by the spiraling success of system performance. The efficacy of this philosophy can further be substantiated by a review of the thermal/altitude testing in 1968. Of the reruns/retests required due to thermal/altitude problems on the system, less than five percent of the failures were attributed to small components such as diodes, transistors, etc.

The personnel assigned to the AP Facility all had the same positive attitude on developing this system. Itek, the camera contractor, maintained a field crew of camera experts at the AP Facility in support of the system. This group rapidly became part of the Lockheed- team. Fairchild personnel attached to AP also joined the team. During the early years, General Electric also had a field crew assigned but on 1 July 1961 the recovery system test and checkout were assigned to Lockheed engineers and technicians.

Because of early design constraints and operational problems imposed by limitations of the boosters, the designers were forced to eliminate as much weight as possible from the payload. The weight limit was

CORONA HISTORY
Volume V

a major design constraint. Qualification testing was limited to small margins over the predicted operational conditions because of these restrictions. Light weight materials such as magnesium and its alloys were utilized wherever possible. Even as the booster capability grew, these weight limitations continued to exist since every pound that could be saved in structural construction meant more film could be flown. In the very early days there were times when filing, chipping, and sawing away the excess were the only solutions.

The camera system design began with a major operational problem as a result of the space environment. The film used in the first C cameras had a triacetate base and became brittle and disintegrated when driven over rollers in vacuum. Numerous tests in thermal/altitude chambers at Itek and Lockheed were conducted in an attempt to solve this problem. Roller adjustments were made, bobber rollers were designed and installed, and many other ideas were attempted, but the problem persisted. What was even more frustrating was that a system that passed the test on the ground would fail in flight. Itek and Lockheed both advised the Government that this problem must be solved by the film manufacturer before successful camera operation on-orbit could be guaranteed.

In 1960, Eastman Kodak was able to produce a polyester base film which they felt would hold the emulsion under vacuum conditions. Two spools of film were shipped to AP. On 15 April 1960, the eighth camera system (Camera C-14) was orbited, and successful operation of the camera was achieved utilizing one of these spools. However, the film was not recovered due to spin rocket failures on the recovery vehicles.

As a result of this failure to recover Mission 9008, the Program Office directed that the program should standdown until the recovery system was made operable. During this period it was discovered that the Mark(MK) IIA Recovery System then in use had deficiencies. Hot gas rockets were used to spin and despin the recovery vehicle but ground testing confirmed that the operational reliability of these rockets was low. The internal batteries of the SRV were also unreliable (small mercury batteries soldered together), and the event timing sequencer which was controlled by a mechanical timer was questionable from the standpoint of both reliability and repeatability. Veiled by these negative elements, the Mark II system was discontinued.

General Electric next produced the MK II/MK IV satellite recovery vehicle which was equipped with electronic event timing and more reliable batteries; however, it retained the hot gas spin rockets. In parallel with the MK IV modifications, Lockheed engineers designed and produced a cold gas spin/despin system which appeared would assure the true ballistic attitude necessary for recovery. Together, the two companies engaged in an around-the-clock qualification program on this new subsystem. Lockheed also developed a diagnostic event telemetry system for failure analysis which was also incorporated with the cold gas spin system.

CORONA HISTORY
Volume V

In June 1960, the first SRV with the cold gas system was launched but it failed to achieve orbit. A backup system was readied and launched on 10 August 1960 and after 17 revolutions, was recovered from the Pacific Ocean on 11 August 1960. This was the DISCOVERER XIII diagnostic package that became famous all over the world as the first recovered object from outer space. On 19 August 1960 another milestone was reached as the first successful air recovery/film package combination was achieved from Mission 9009. The CORONA Program had successfully demonstrated that aerial reconnaissance on any desired area could be performed from a satellite.

In 1962, with the combined events of intense solar flare activity, the [REDACTED] and later the [REDACTED] On Missions 9038 - 9041 (Cm-7 through Cm-10) nearly 50 percent of the recovered film was seriously degraded. Extensive studies were made by the Lockheed Research Division on the types of materials/designs to be used for shielding to protect the payload. As a result some of these designs were fabricated and used on a number of systems. At the same time, testing in vacuum chambers isolated the rubber metering rollers as a medium which was acting as a generator and discharging static electricity causing exposure markings on the film. These electrostatic dendritic-shaped markings were aptly named "corona" discharge markings. Application of an antistatic coating used on the rollers temporarily allowed flights to continue while experiments on more conductive rollers were performed by Itek. Simultaneously, tests by Itek and Lockheed determined that the discharges occurred predominantly in the pressure range of 10 - 100 microns. Ion gauges developed by Lockheed were flown in each mission to correlate and substantiate the actual pressure on-orbit. Final solution to the problem was achieved when Lockheed developed a pressure makeup system (PMU) from which the system pressure on-orbit could be adjusted to a noncritical level depending upon the type of film flown. On later J-3 flights, the PMU option was successfully utilized on the DISIC camera, as well as the panoramic cameras.

With the pressure of meeting launch schedules, early test plans and procedures were mostly hand written or "red-lined" as systems progressed. Team testing with system test personnel, camera and recovery experts, and data analysts was utilized to assure continuity of testing. These teams picked up the subsystems upon receipt at AP and conducted acceptance testing; assembled and tested the system; transported the system to VAFB; launched it; controlled it on-orbit; removed the film after recovery; and shipped it to its designated processing and duplication facility. In 1962, with the issuance of AP Standard Operating Procedures, the first standard and more formalized test procedures were produced. In 1964, these test procedures were computerized.

As aforementioned, system qualification testing was limited. Not until the J-3 Program did CORONA

CORONA HISTORY
Volume V

have the time and funds to build a qualification vehicle (QR-2). In fact, later in the program the QR-2 system was refurbished and flown. Each system was subjected to environmental acceptance testing in vibration, shock, and thermal/altitude simulation. Of all the testing, the thermal/altitude simulation became the most valuable measure because it provided the best environment from which the overall system performance could be effectively evaluated and predicted. When the factory to launch concept was instituted, this test became the final acceptance test of the system prior to shipment to the VAFB launch site.

Meetings were held in the spring of 1965 between Lockheed, GE, Itek, [REDACTED] and the CIA to examine the feasibility of a CORONA improvement program. Failure modes and operational deficiencies of the existing J system were studied as were coverage requirements, weather data, and overall system reliability data. From these studies, a matrix of feasible system designs was developed along with all recommended designs incorporating advanced panoramic and Stellar/Index camera systems and an improved command system. This work led to the development of the J-3 system.

A "go-ahead" was issued in July 1965 to Douglas (THORAD), Fairchild (DISIC camera), and Itek for manufacturing its Constant Rotator (CR) camera. However, delayed issuance of an approval to Lockheed and GE until April 1966 resulted in a six month delay in the originally scheduled first launch of the J-3 system. The first launch (Mission 1101) was rescheduled for 25 July 1967.

Schedules of critical design reviews, a qualifying test program, hardware deliveries, and system test activities were established to meet this date. Final design reviews for the camera, SRV, electrical system, structural aspects, and total payload were set for 23 August 1966, 7 September 1966, 7 October 1966, 17 February 1967, and 14 April 1967, respectively. All were conducted according to plan. Deliveries of the camera systems and SRVs to AP were several weeks behind the target schedule; however, these time slippages were made up during system testing. The J-3 qualifying program proceeded smoothly throughout the test cycle. In early July 1967, it appeared as though the target launch date would be met; however, a corona marking problem was uncovered on both the panoramic and DISIC cameras during thermal/altitude testing, and two High Vacuum Orbital Simulation Chamber (HIVOS) test reruns were required. This delayed the first J-3 launch to 15 September 1967, approximately seven weeks behind the target date of 25 July 1967.

Any effort to name even those who made major contributions would result in a lengthy list. However, in behalf, and representative, of all of the people who made CORONA the great success it was, photographs are included as Figures 1-4 and 1-5 showing some of the personnel who worked on this program.

***** NOTICE OF REMOVED PAGES *****

Pages 1-13 and 1-14 of CORONA, ARGON, LANYARD programmatic information are not provided because their full text remains classified.

~~TOP SECRET~~

EVOLUTION
OF THE
CAMERA SYSTEMS

~~TOP SECRET~~

Handle via 
Controls On

~~TOP SECRET~~

CORONA HISTORY
Volume V

SECTION II

EVOLUTION OF THE CAMERA SYSTEMS

C AND C PRIME (C') CAMERA SYSTEMS (1958-1959)

The original C camera was a scanning panoramic instrument with an oscillating lens cell. Seventy millimeter film was fed from a supply spool through special drive mechanisms to a curved platen area where it was exposed. The exposed film was then transported into a takeup spool in the recovery system. Before ejection of the recovery system from the satellite, a cut and seal device closed/sealed the cover of the recovery capsule to protect the film. The in-flight programmable camera and V/h ratio were fixed and preselected prior to launch. The image motion control was fixed mechanically to the V/h ratio. Two Horizon cameras were used for attitude determination. System time was recorded on the film by imaging the numbers displayed on a system clock known as a Digitote.

The structure was a thermally shielded conical fairing with three pyro activated ejectable photographic doors, light tight boots around the lens, and electrical harnesses as required. The recovery system was a MARK IIA satellite recovery vehicle equipped with a single parachute, hot gas spin/despin rockets, chaff for radar detection, and a seawater dye marker for water recovery. The re-entry vehicle had a design goal capacity for handling 20 pounds of film.

Problems encountered by AP early in the program included the need to develop structural components compatible with launch and space environments. Weight limitations caused by booster structure/capabilities were of prime concern. Light weight materials such as magnesium alloy, aluminum, and titanium were utilized wherever possible. In 1959, load/stress testing in Sunnyvale, using early predictions of ascent heating on a fairing, weakened the structure causing it to collapse. Further analysis led to design changes which solved the problem. A major effort was put forth in developing a passive on-orbit thermal control system to protect the camera and recovery systems. This effort became a controversial subject for years between contractors and even between Government agencies.

A requirement to have an on-orbit command and control system with readout instrumentation for prelaunch and in-flight status led to a subcontract with Fairchild. This contract was for the production of an orbital programmer to control the events of the AGENA and the photographic payload. Checkout of this programmer was originally accomplished at the AP Facility but was later transferred to Sunnyvale and finally to VAFB. This orbital programmer with its subsequent improvement modifications was utilized throughout the CORONA Program.

~~TOP SECRET~~

CORONA HISTORY
Volume V

Early in the development of the system, many technical experts lacked confidence in the camera subsystem through the boost/ascent phases. To counteract this lack of confidence, a research payload (named GRD) was counted down in parallel with the first CORONA system in case a decision was reached to delay the CORONA launch. Originally, the philosophy of flying the camera subsystem consisted of mating the photographic system, launching, and starting the camera on-orbit when desired. However, as failures continually occurred, this philosophy changed. The camera was operated on the pad after mating to the vehicle to assure proper tracking operation before launch. This method of certification remained an operational procedure throughout the life of the CORONA Program.

The use of polyester film and the changes in the recovery system have been discussed in earlier volumes and will not be repeated here. With the successful operation of the first system accomplished, it was realized that many modifications were needed. Some of these changes included a V/h programmer to achieve better forward motion compensation to improve resolution, and changes in the recovery system to increase film capacity to 40 pounds. Lockheed continued to manufacture the cold gas spin system, the cutter/sealer device, and to furnish the parachute. A schematic drawing of the C and C' payload is presented in Figure 2-1. Figure 2-2 photographically illustrates some of the final assembly phases of the payload subsystem at AP.

The C contract was awarded to Lockheed on 25 April 1958 for 12 systems. Figure 2-3 shows the organizational structure that handled this contract from March 1958 to April 1961. Ten systems were launched and two were delivered to the Government for storage. The first system was launched on 25 June 1959 and the last on 13 September 1960. For those launched the status was: four failed to achieve orbit; four failed on-orbit and no separation was accomplished; one separated but was not recovered (DISCOVERER V); and one was successfully recovered.

The C' contract was awarded to Lockheed on 26 July 1959 for eight systems (later changed to eleven). Mission duration went up to two days. Ten systems were launched and one was delivered to the Government for storage. The mission duration for C' was increased to two days. The first system was launched on 26 October 1960 and the last on 15 November 1961. Of these, four failed to achieve orbit; one separated but was not recovered; and five were recovered.

Predicted performance of the C and C' systems at 125 nautical miles altitude was:

Coverage - 6,800,000 square nautical miles per mission
Resolution - SO-102 Film - 55 lines per millimeter
25 feet ground resolved distance

C, C' PAYLOAD SUBSYSTEM

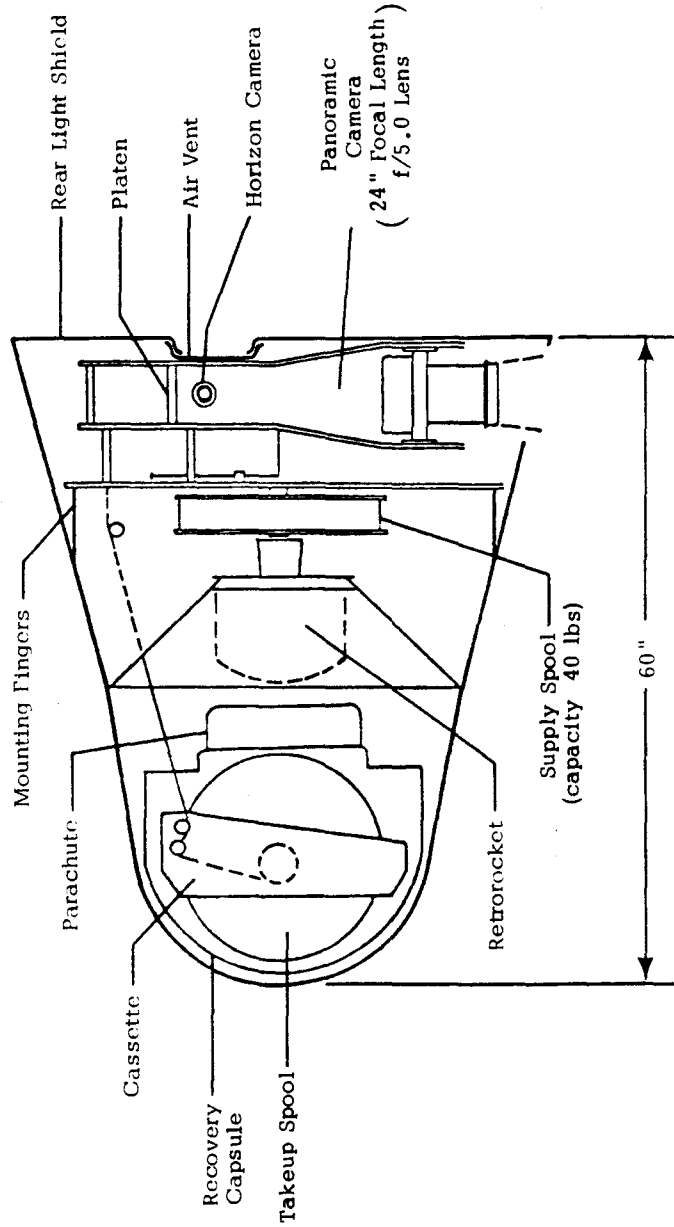
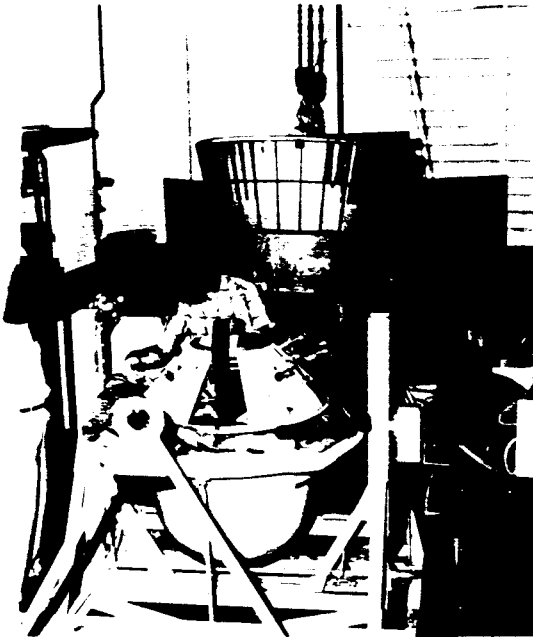
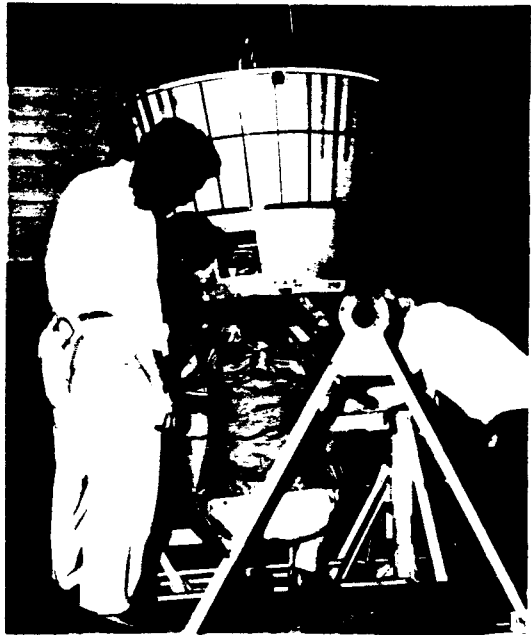

Figure 2-1

FINAL ASSEMBLY OF THE PAYLOAD OF A "C" SYSTEM



Camera System Hoisted above the SRV
(L-R) [REDACTED]



Mating the Camera System to the SRV



Final Mating Position Check

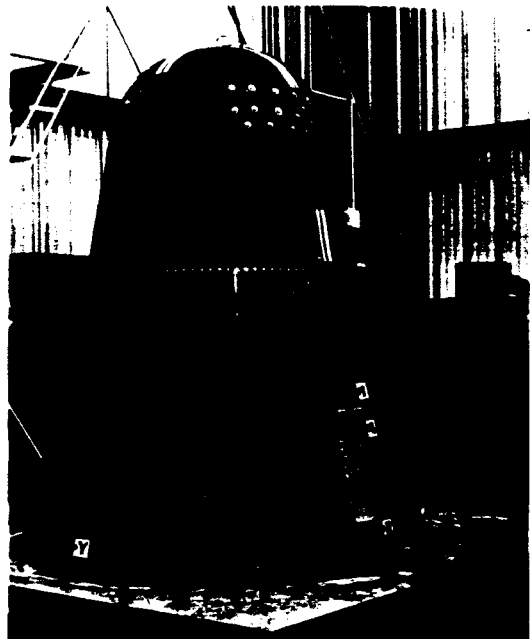

System Vibration Check

Figure 2-2

CORONA CONTRACT ORGANIZATIONAL STRUCTURE (Mar 58 - Apr 61)

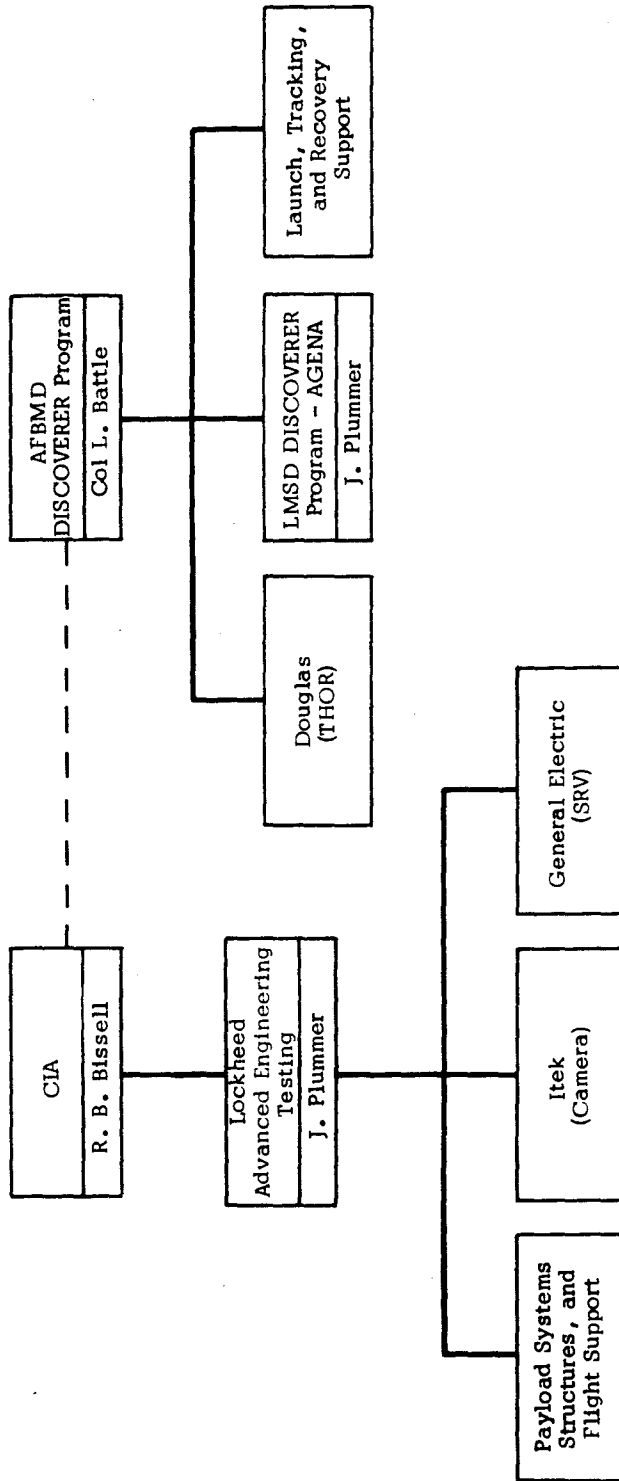

Figure 2-3

CORONA HISTORY
Volume V

ARGON SYSTEM (1959-1960)

In August 1959, a satellite mapping camera program called ARGON (CORONA-A) was started. ARGON was primarily funded by the Army for the purpose of obtaining cartographic coverage. Lockheed was selected as prime contractor and Fairchild Camera & Instrument Company and the General Electric Company as subcontractors. Figure 2-4 outlines the contractual relationships involved in this program. The system consisted of a pressurized mapping camera composed of a Geocon 3 inch focal length f/2.5 lens for the terrain mission and a 3 inch focal length f/2.0 for the stellar mission. The two exposure times were synchronized to one millisecond.

The camera system was pressurized to enable the film to be precisely flattened on the platen during exposure by opening the back side of the platen to vacuum. Film was fed from the supply spool through drive mechanisms to the terrain and stellar platens where it was exposed. It was then driven through a pressurized film chute to the recovery vehicle takeup spool. Forty pounds of 3.0 mil mylar based, 5 inch wide film was used on the system. Data recorded on the film included pitch and roll attitude (fed from the AGENA telemetry), direction of flight indicator, shrinkage markers, optical fiducials, camera number, clock word, and vacuum to platen status.

For geodetic purposes an accurate clock was required which was able to record simultaneous system and telemetry time. Fairchild, under a subcontract to Lockheed, developed and produced the Digital Time Interval Recording Clock for this purpose. Because of its accuracy and reliability this recording clock was used during the CORONA Program from 1960 to 1972.

The MARK V recovery system was also pressurized. It had a capacity for a 5 inch takeup instead of the 70mm takeup used in the C system. Figure 2-5 is a schematic drawing of the ARGON payload subsystem.

The payload system was designed to operate at 165 miles altitude for six days, which was a significant improvement from the C system that had a one day operation as its original design goal. The first ARGON system was launched in February 1961; however, numerous anomalies occurred causing its failure. The problems that surfaced with this program were the operation of the camera shutters and timers were inconsistent and the booster unreliable. In addition, there was a problem from the pressurized system that had not been anticipated and that was the residual gas left in the system prior to the recovery operation. In the operational sequencing, separation of the bellows that connected the camera chute to the recovery vehicle was timed to occur at the same instant that the recovery vehicle was separated for de-orbit. However, entrapped gas pushed the recovery vehicle into a new orbit before spin-up, thus causing a perplexing situation for the design engineers. Needless to say, on the next launch the system was depressurized before ejecting the

ARGON CONTRACT ORGANIZATIONAL STRUCTURE

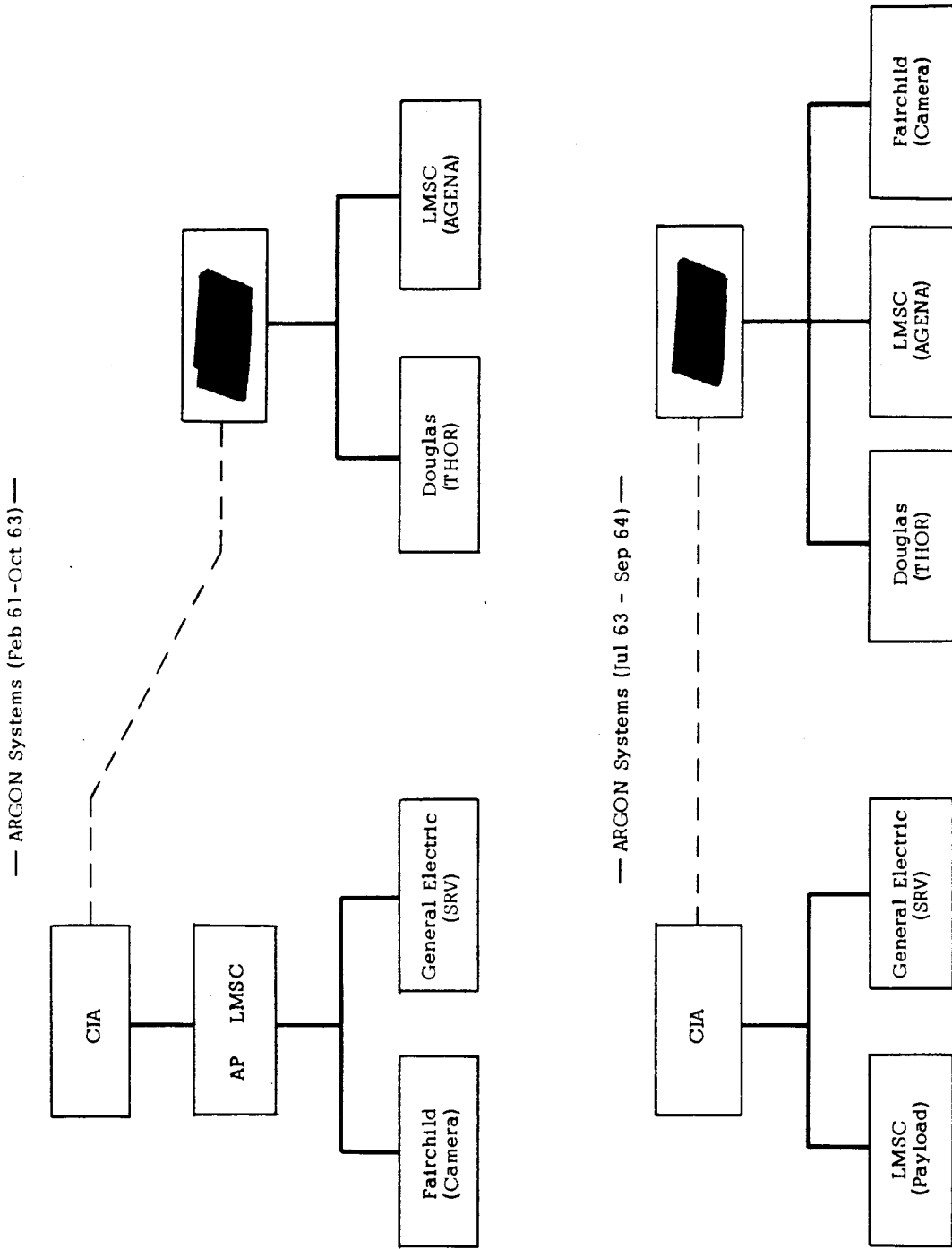

Figure 2-4

Handle via [redacted]
Controls Only

ARGON PAYLOAD SUBSYSTEM

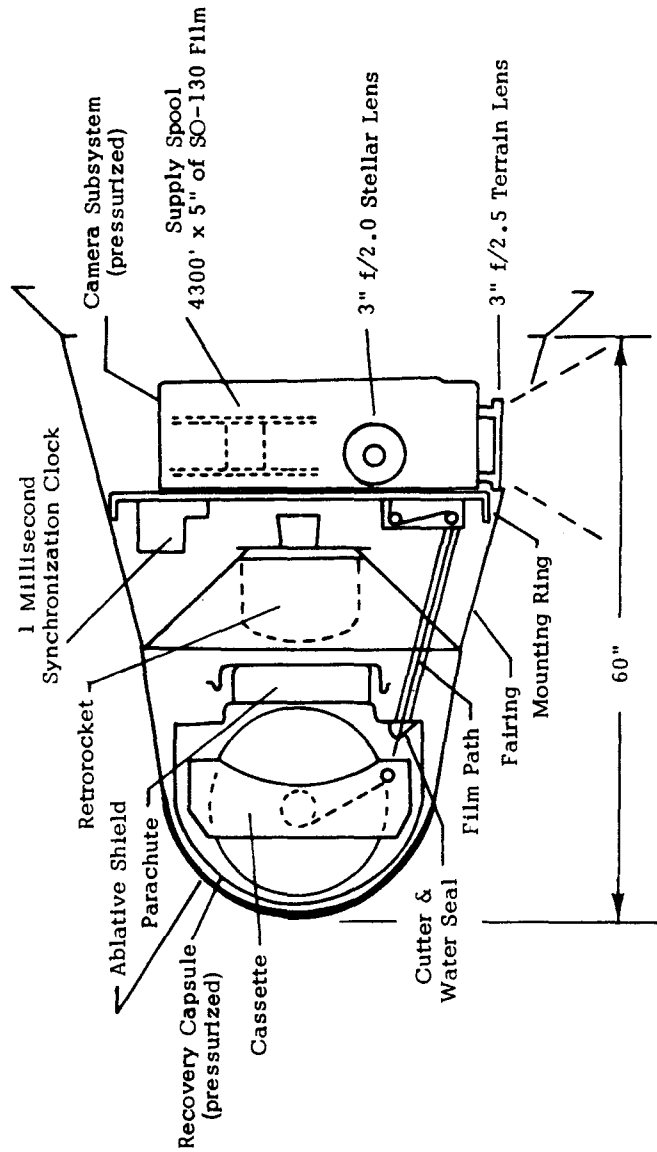

Figure 2-5

CORONA HISTORY
Volume V

recovery system. After these problems finally were resolved or suppressed, an ARGON system was launched and recovered successfully in May 1962. The first ARGON system was launched on 17 February 1961 and the last of this block of systems on 29 October 1963. Ten systems were launched of which three failed to achieve orbit; two failed to separate; one separated but was not recovered; and four were recovered.

A follow-on ARGON contract was awarded on 23 September 1963, retroactively effective 15 July 1963, for four systems. Under this contract the camera systems were furnished by Fairchild and the SRVs by GE, while AP furnished electrical boxes and structures and acted as integrating contractor. The first of these follow-on systems was launched on 19 June 1964, and the second on 21 August 1964. Both capsules were successfully recovered. The other two systems were sold to the Government in an "as is" condition, the first on 4 September 1964 and the second on 22 September 1964. Both of these systems were returned to AP and were packed and shipped to Government storage.

The predicted performance of the ARGON system at 165 nautical miles altitude over the prime mapping objective area (80°N to 55°S latitude) was:

- Terrain Resolution - 330 feet ground resolved distance
- Stellar Resolution - 515 magnitude stars
- Locational Accuracy - 700 feet

C TRIPLE PRIME (C''') System (1960-1961)

It was soon realized that there was little potential for future improvement of the C' Program and as a result an Improvement Program Committee was established. This committee consisted of representatives from the Government, Lockheed, General Electric, and Itek. Meetings were held and design goals established centering around increasing the operational reliability and improving the photographic quality through changes in the panoramic camera system. Two proposals, referred to as C-61 or the C'' (Double Prime) system, were forwarded to the CORONA Program Office for consideration in early 1961. These two designs were proposed by Itek and Fairchild Camera and Instrument Company. After many negotiations, decisions, and even a cautious start on Fairchild's concept, Itek's proposal was selected and became known as the C''' (Triple Prime) system. At that point all references to C'' were cancelled. The C''' contract was awarded on 27 June 1960 for six flight systems. The first launch was on 30 August 1961 and the last on 13 January 1962 with the following results: one failed to achieve orbit; one failed on-orbit; and four capsules were recovered.

It should be noted that the camera subsystems utilized under the C, C', C''', and ARGON Programs were single camera subsystems which furnished only monoscopic photography. However, starting with the MURAL and J Programs a dual camera subsystem was utilized which was capable of obtaining stereoscopic photography.

CORONA HISTORY
Volume V

The C'' camera was a single scanning panoramic instrument with an oscillating element in the optical system. It was designed to operate at 100 - 110 nautical miles altitude and to achieve resolutions of 80 - 110 lines per millimeter. The supply consisted of 40 pounds of unperforated thin base 3.5 mil mylar 70mm film. The film was fed from a lightweight supply spool through drive and metering mechanisms to a curved "rail" structure where it remained stationary during exposure. The lens cell scanned past the rail to image the coverage on the film. The film was then fed to a takeup cassette in the recovery subsystem. Image motion compensation (IMC) was accomplished by a mechanical cam which caused the lens system to move opposite the direction of flight during scan and then return for the next cycle. Two Horizon cameras with a 90mm focal length and a shutter speed of 1/200 second were used for attitude determination.

The main camera lens was a 24 inch focal length f/3.5 Petzval type system designed for a 70mm slit format. A preset slit width and a Wratten 21 Filter were used. Exposure time was determined by the motor speed which was controlled by the V/h input derived from one of the ten selectable levels programmable by a real time command.

Time was recorded on the film by registering the binary numbers displayed from the system clock. Time marks of 200 cps, fiducial marks, the camera serial number, a center of format marker, and shrinkage markers were recorded on the edge of the film.

The preset tape-stored commands included camera on-off, V/h stepping, and recovery. The real time commands were V/h starting and recovery commands. Telemetry data reported status for V/h readout, voltage, film footage, light leak sensors, temperature, and other operational and diagnostic information.

The payload structure consisted of a passive, thermally shielded conic fairing housing for the camera, film supply, light tight boots around the lenses, electrical harnesses, and instrumentation, see Figure 2-6. There were three optical doors which were designed to blow off during ascent. The SRV was attached to the fairing. A single recovery system, MARK IV, with a dual parachute and a cold gas spin/despun system was used. An AGENA served as the second-stage and orbital stable platform, while the THOR was the booster stage.

MURAL SYSTEM (1961-1962)

MURAL (M) was the first stereo camera system in the CORONA Program. Two 24 inch focal length panoramic cameras were mounted in a 30 degree convergent stereo angle. The 70mm film was fed from a double spool film supply cassette with one of the two film webs going to each panoramic instrument through a twisting system of drives, rollers, and clamps. The film was exposed through 70 degrees of lens cell angular rotation and then fed to a double spool takeup cassette in the SRV. Simultaneous operation of both instruments was required for stereo photography. Figure 2-7 presents an illustrated profile of the M payload subsystem.

C-111 PAYLOAD SUBSYSTEM

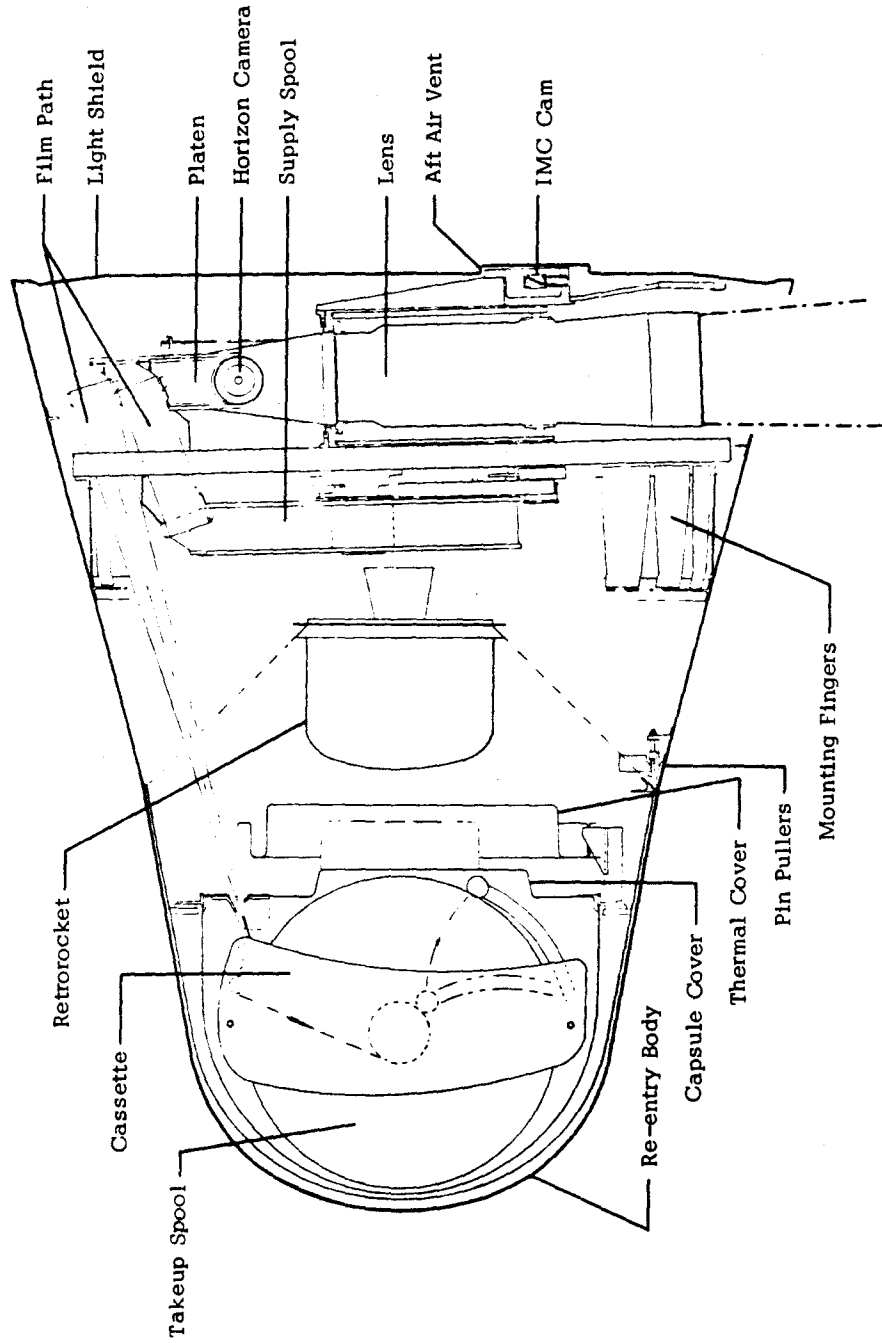

Figure 2-6

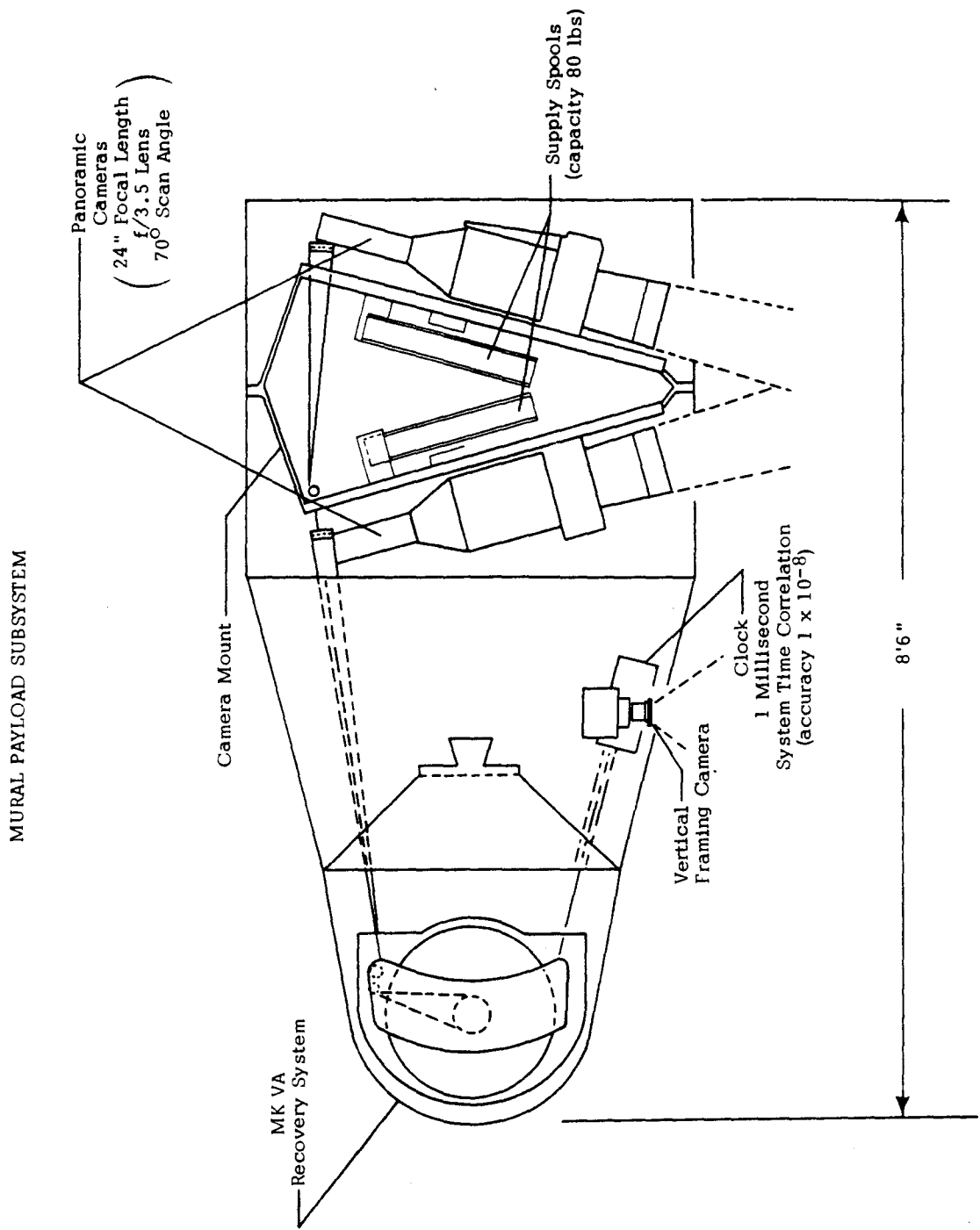

Figure 2-7

Handle via [REDACTED]
Controls Only

CORONA HISTORY
Volume V

Figure 2-8 shows a photograph of a system being readied for collimation testing.

Prime attitude information was provided by one Stellar/Index camera utilizing 70mm film with a 1.5 inch focal length $f/4.5$ lens for index (terrain) information and 35mm film with an 85mm focal length $f/1.8$ lens for attitude (stellar) information. Backup attitude information was provided by the Horizon cameras with a 90mm focal length $f/6.8$ lens.

The system was designed for nominal altitudes of 110 nautical miles with a mission duration of up to four days. Dynamic resolution was designed to be 80 to 110 lines per millimeter.

With the incorporation of a stereo system, modifications were required on the command/control, instrumentation, and telemetry systems. Incorporation of the Stellar/Index camera subsystem created real problems on the MURAL Program because it was continuously plagued with failures and breakdowns.

The MK VA recovery system utilized was nonpressurized and capable of handling up to 80 pounds of film. Basically, this recovery system was utilized throughout the balance of the CORONA Program.

On Mission 9051 (Cm 18) the orbiting vehicle did not pitch down properly for separation. As a result the recovery capsule landed in the ocean approximately 1,000 miles from its predicted impact point. Both the beacon and telemetry antennas burned in half due to very high re-entry heating, but the recovery aircraft were able to maintain tracking. The capsule was actually sited in the evening, but it was felt that it was too late to attempt a recovery from the water at that time. A decision was made to monitor the drift of the capsule by the beacon signal and make the pickup the next day. Some time during the night the beacon signal disappeared, and it was assumed that the battery had reached its limit. Luckily, searching aircraft located the vehicle the next morning floating upside down by means of seeing the reflections of the sun off the gold thermal covering of the capsule. The capsule was retrieved and all 78 pounds of film saved. However, a new problem had emerged and that was the instability of the capsule while in the ocean. Lockheed designed a swing down ballast to keep the capsule upright even in heavy seas. This swing down ballast was utilized throughout the J-1 Program.

The first M flight system was launched on 27 February 1962 and the last on 21 December 1963. There were 26 systems launched with the following results: two failed to achieve orbit; four capsules separated but were not recovered; and 20 capsules were recovered. Performance of the MURAL system exceeded design specifications. When operating at 125 nautical miles altitude, stereo coverage totaled 6,800,000 square nautical miles, and the system achieved a resolution with SO-132 Film of approximately 125 lines per millimeter and ten feet ground resolved distance.

MURAL SYSTEM BEING LOWERED ONTO BLOCK FOR COLLIMATION TESTING

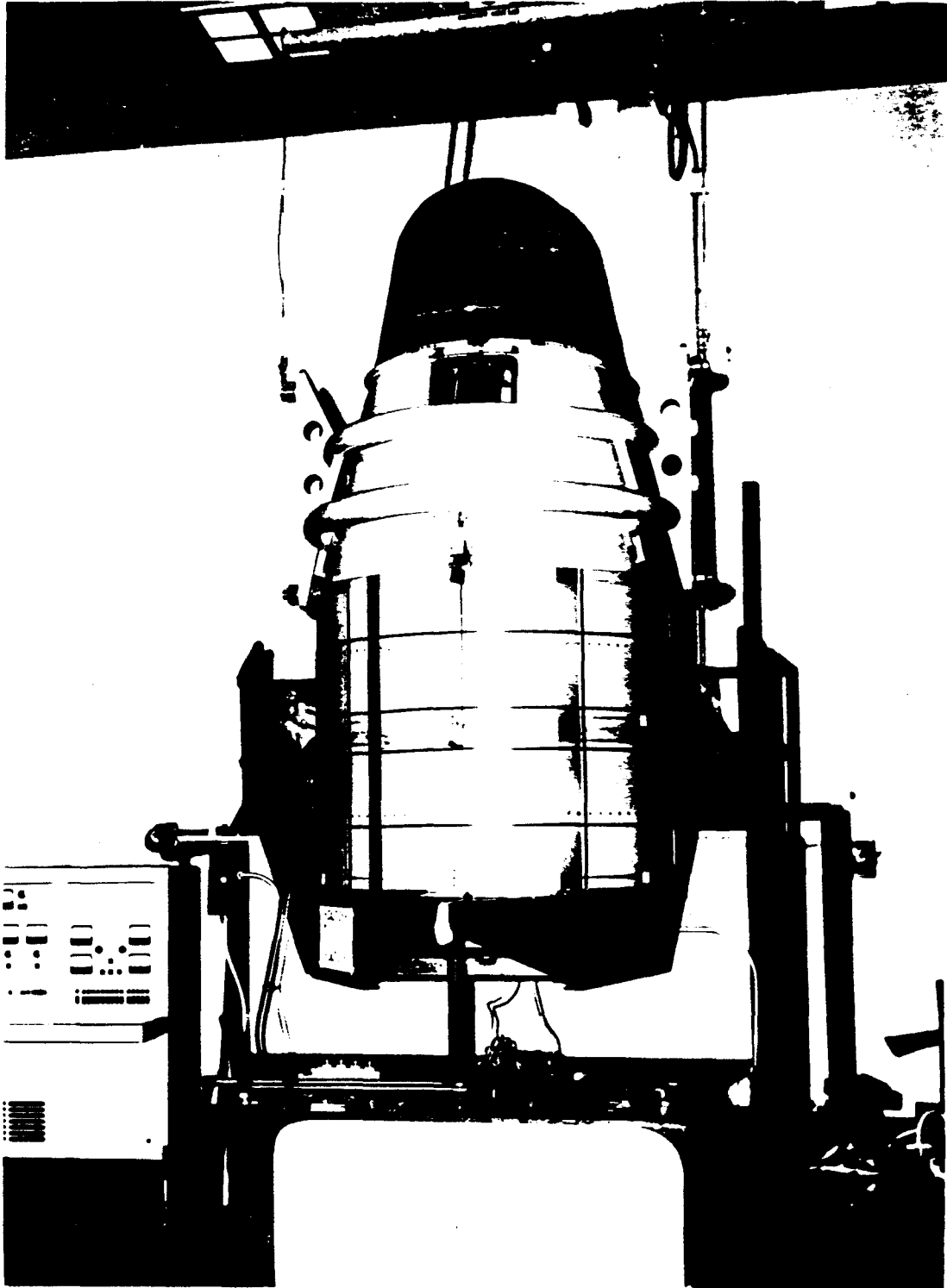

Figure 2-8

Figure 2-9 outlines the organizational responsibilities for the MURAL Program contract.

LANYARD SYSTEM (1962-1963)

The LANYARD (L) camera system contract was awarded on 2 August 1962 for five satellite reconnaissance systems with stereoscopic photographic capabilities. The camera subsystems were furnished as GFE by Itek, an associate contractor, and the SRVs by GE, another associate contractor. The contract also stipulated that Advanced Projects should furnish systems engineering for the Government through August 1963. The number of flight systems was later contractually increased from five to eight, and the systems engineering period of performance amended to cover the period of 22 February 1962 through 31 October 1962. Figure 2-10 shows the contractual relationships for LANYARD. The system design goal was to achieve ground resolution of four to five feet at an altitude of 112 nautical miles for a duration of four days.

Both stored and real time commands were utilized for system decoder and recovery operations. The decoder selected operate programs and controls a roll joint. Telemetry provided channels which were continuously transmitting diagnostic and operational data.

The L system was a panoramic spotting camera with an oscillating lens cell viewing a large mirror which was pointed at a 45° angle toward the earth. Movement of the mirror enabled the system to produce stereo or mono photography. The 5 inch film was fed from a supply spool (capacity 8,000 feet or 80 pounds) to the platen for exposure and then to a takeup cassette in the recovery system. The effective focal length of the optical system was 66 inches.

The time word (from a data head driven by the digital recording clock generator) and other data on attitude, roll steering, and rate were imaged on the film. The system included a Stellar/Index camera which provided pitch and roll information and tracking correlation for the panoramic camera. The payload structure consisted of a 60 inch barrel and a fairing. On the aft end of the barrel was a counter-balanced roll joint enabling the entire payload to rotate by command to the various pointing angles. All structures were thermally shielded. A modified MK VA recovery system was used with a double parachute and cold gas spin system. The AGENA D served as the second-stage and orbital stable platform, and the Thrust Augmented THOR (TAT) was the booster. A schematic drawing of the L system payload appears as Figure 2-11.

On 23 October 1963, the contract was curtailed, and the number of flight systems was reduced from eight to the three which had already been launched. The results of those missions were: the first (18 March 1963) failed to achieve orbit, but the second and third (18 May 1963 and 30 July 1963) were both successfully recovered.

MURAL CONTRACT ORGANIZATIONAL STRUCTURE (Apr 61-Oct 62)

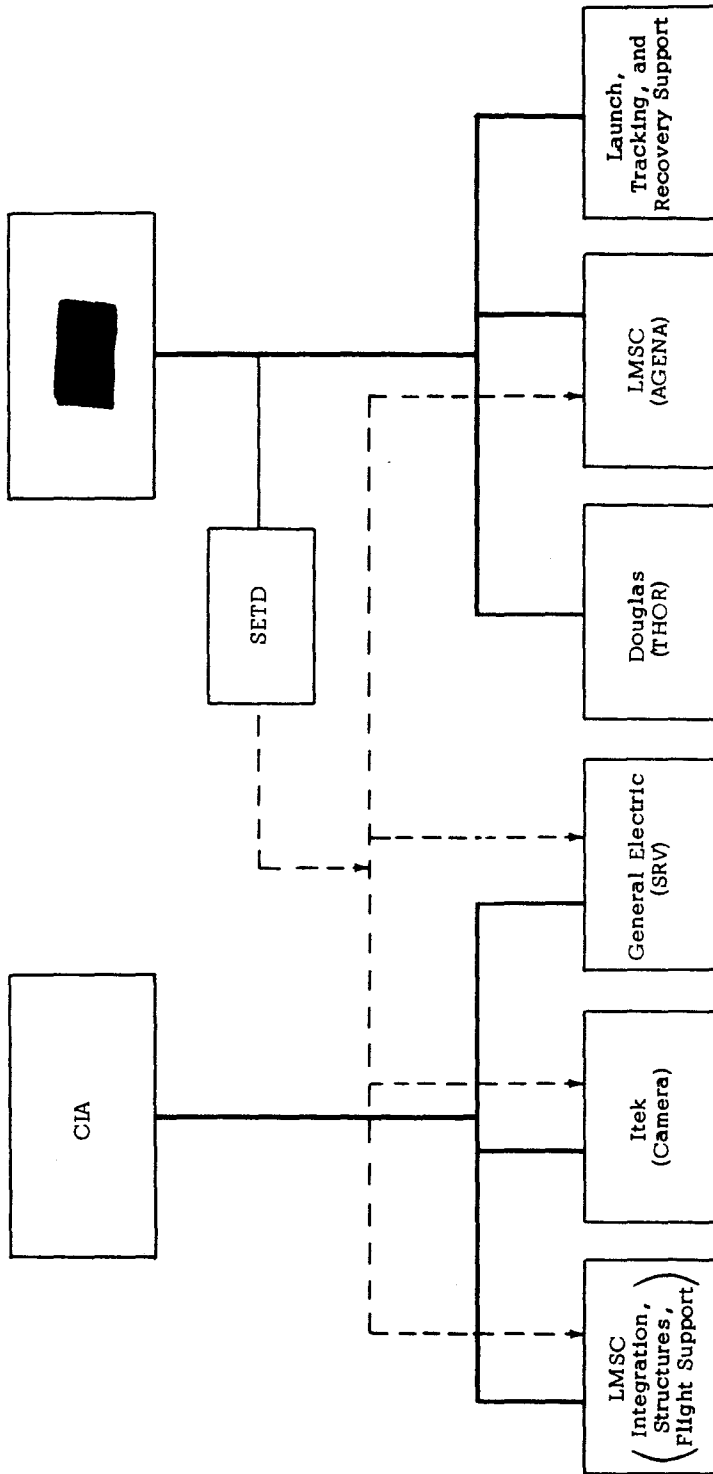

Figure 2-9

LANYARD AND JANUS CONTRACTS' ORGANIZATIONAL STRUCTURE (Nov 62-Aug 64)

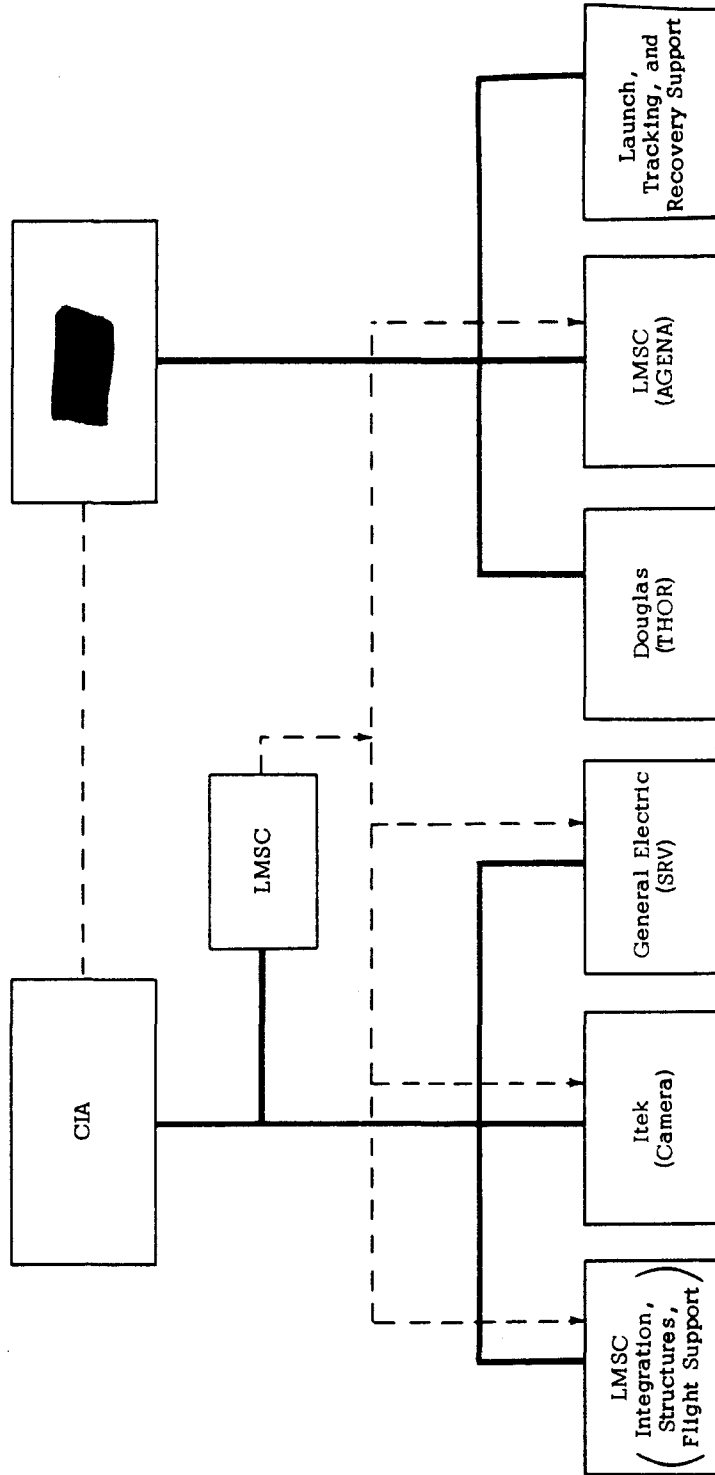

Figure 2-10

LANYARD PAYLOAD SUBSYSTEM

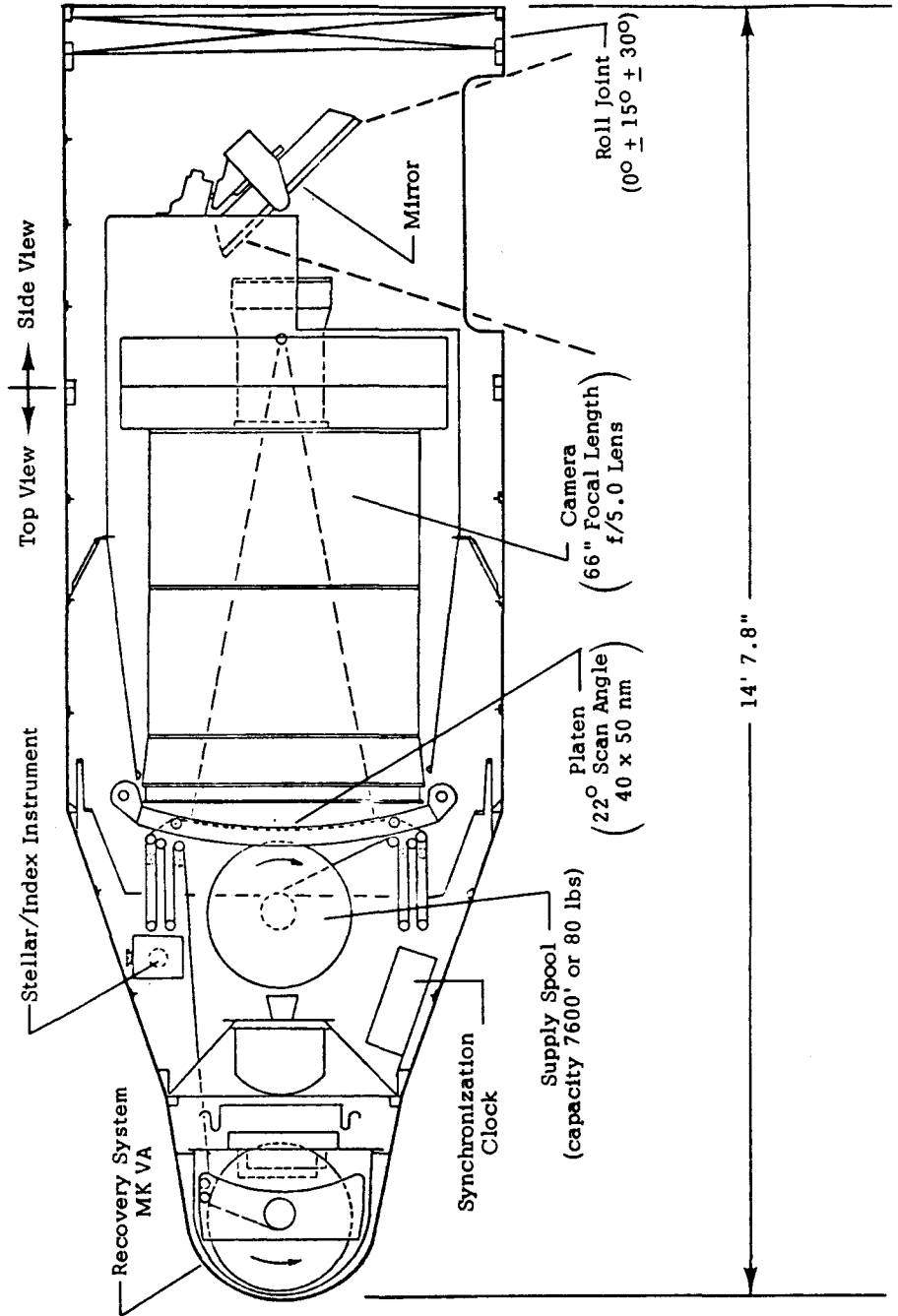

Figure 2-11

CORONA HISTORY
Volume V

The L system was operated on the second and third flights at approximately 90 nautical miles altitude and produced best ground resolved distances of 5.5 feet on SO-132 Film. The ground coverage varied from 660,000 to 1,320,000 square nautical miles dependent on the relationship between the monoscopic and stereoscopic operations.

JANUS (J-1) SYSTEM (1963-1969)

With the stereo capability of the MURAL Program proven and the longer life of components and subsystems now possible, the next goal for the reconnaissance satellites was to increase film capacity. With this in mind, the JANUS (J) Program was conceived. The first system in the JANUS series was called the J-1, which was designed with a dual re-entry payload. Research had been going on since late 1962 at AP on this type system. Finally in March 1963 approval was given to have the same organizations that worked on LANYARD develop the J-1 system. Figure 2-10 shows the contractual structure. This system became the work horse of CORONA. Fifty-two systems were launched, with the first in August 1963 and the last in September 1969. The mission duration grew from five to a fifteen day life cycle. Design also included a deactivate period mode (Zombie) so that the system could be stored on-orbit for up to 20 days between recoveries if desired.

Major redesign of the command and control subsystems, the pyro subsystems, and telemetry was required to accommodate the expanded operational requirements. For some period the decision on how to transfer one recovery capsule to the other was unresolved, with technical experts backing both the cut/splice and cut/wrap techniques. It was finally proven on the J-1 and J-3 systems that the cut/wrap technique was best. The cut/wrap technique was used on the follow-on programs.

Two major problems emerged at AP during the initial assembly stages of J-1. One was a film tracking problem through the system and the second was the cut/wrap sequence. The fourth model of this system was taken off the line and utilized as a test bed to solve these problems. The combined effect of redesigning the rollers, making critical adjustments, changing the "B" takeup electronics, and the dedicated skill and knowledge of the test personnel resulted in the successful solution of these problems.

With the increased on-orbit life of the system, the success of recovering the "B" (second mission segment) capsule became jeopardized due to the limited life of the pre-activated recovery battery. A new, longer capacity battery was developed to overcome the long idle time encountered, this battery was named "Dreamboat."

With the intelligence community continuing to request more information, the J systems were launched at a rate of better than one a month during 1964 and 1965. In 1966, the number of launches were reduced to nine.

~~TOP SECRET~~

CORONA HISTORY
Volume V

In April 1965, Itek was awarded a contract to provide a pan-geometry (PG) capability for the J-1 cameras. This would allow the mapping and charting community a means to more accurately determine the geographic location of targets on CORONA photography. PG consisted of providing "rail holes" with an appropriate light source (lamps) so that a reseau could be determined and an IMC trace imaged on the panoramic camera film. Using calibrated data from the cameras, the cartographic community would then be able to reconstruct the internal geometry of the camera system. A design goal was to have the accuracy of producing maps in the 1:50,000 scale range.

In September 1966, the first CORONA pan-geometry mission was flown. The results were generally favorable but insufficient to allow the user community to conduct a statistical evaluation. However, the second flight in November 1966 gave sufficient data for a user evaluation, the results were a mixed lot of pros and cons; but the decision was to keep flying the PG subsystem.

The success of the J-1 Program can be measured by its results. Of the 52 systems launched, two systems failed to achieve orbit (four capsules); six capsules were not recovered; while the remaining 94 capsules were recovered. The J-1 system, at 125 nautical miles altitude, produced 13,600,000 square nautical miles of stereo coverage per mission and achieved ground resolved distances of 10 feet and resolutions of 125 lines per millimeter.

A schematic drawing of the J-1 system is presented in Figure 2-12. Figure 2-13 is a photograph of the J-1 system in the process of going through a portion of the "vertical" testing.

JANUS (J-3) SYSTEM (1967-1972)

The next operational phase of the JANUS series was the J-3 system which was designed to acquire improved stereoscopic photographic reconnaissance for intelligence information; provide a base for establishing a means to evaluate the correlation between cartographic and geodetic sources; and to photograph special items of interest. These special requirements might include different types of films (high resolution, color, camouflage detection) for use in determining the geologic, economical, as well as military potential of a given area of interest. Another system was being designed during the same time period as the J-3 research/proposal stage. This system, designated as J-2, consisted of a J-1 panoramic camera, a Dual Improved Stellar Index Camera (DISIC), and an improved THORAD booster. However when approval was given for complete development and implementation of the J-3, all work and reference to the J-2 configuration was terminated.

~~TOP SECRET~~

J-1 PAYLOAD SUBSYSTEM

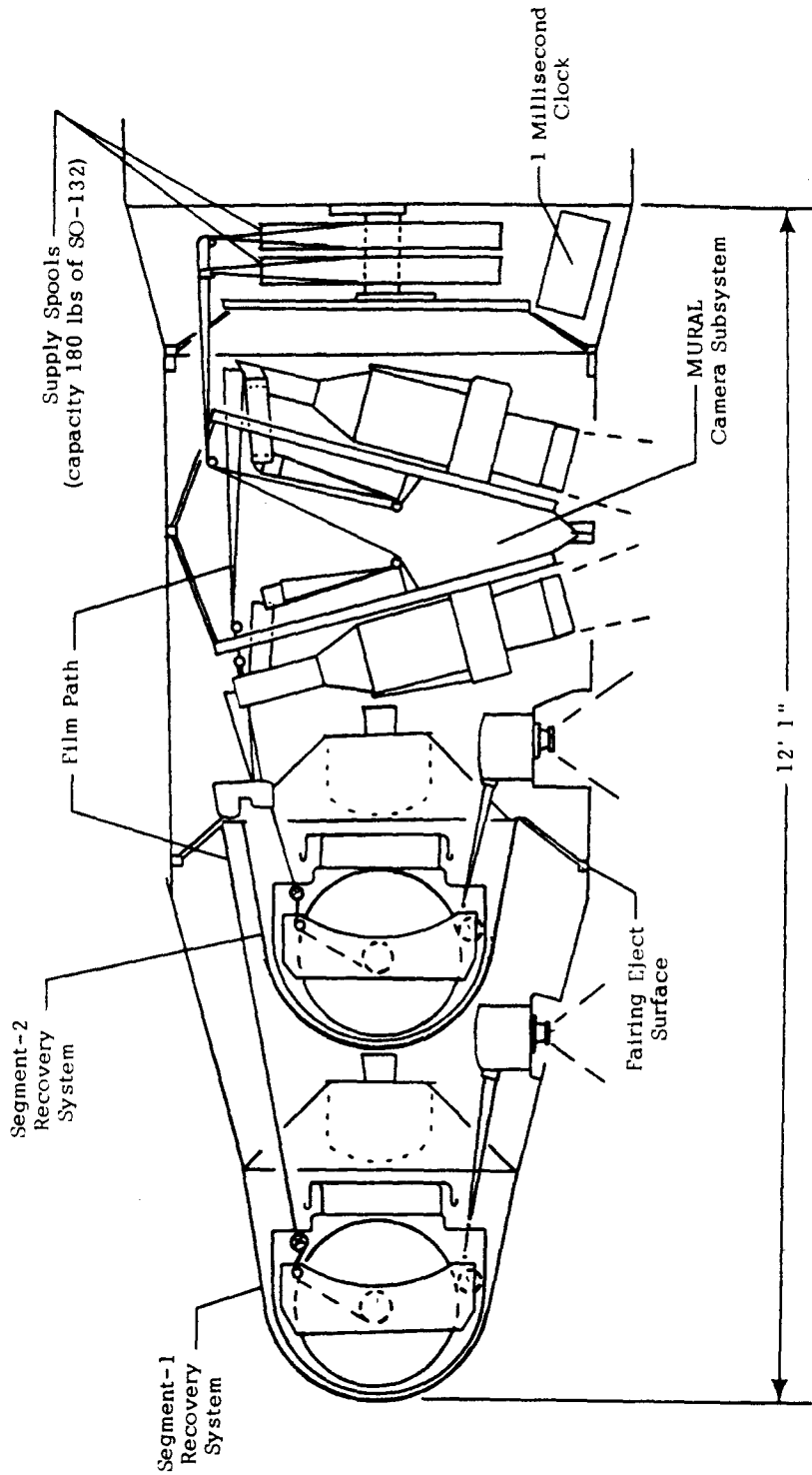

Figure 2-12

J-1 SYSTEM IN TEST CONFIGURATION

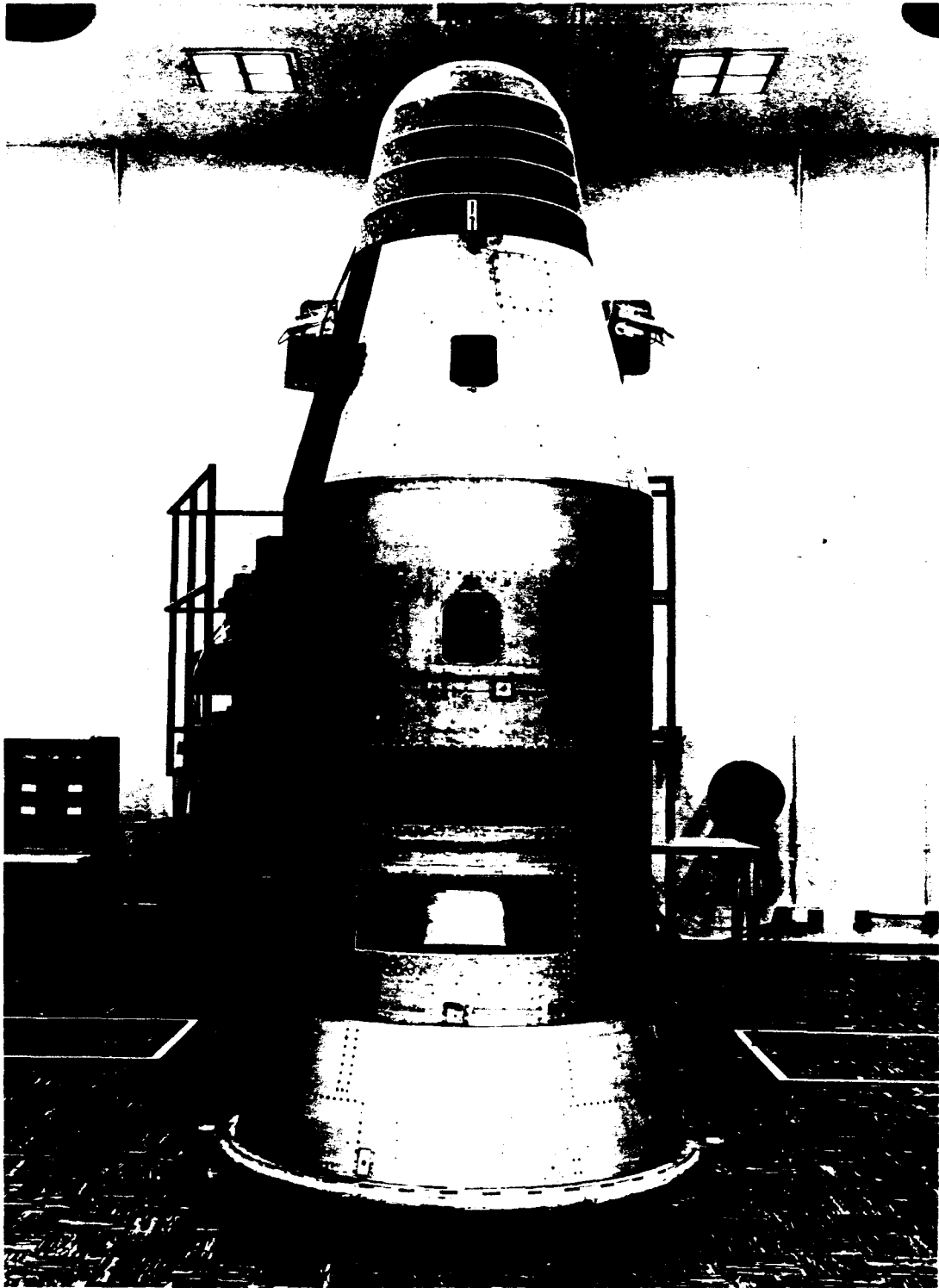

Figure 2-13

CORONA HISTORY
Volume V

The J-3 (Constant Rotator) camera system consisted of two panoramic instruments, each with a constant rotating lens cell, mounted at a 30 degree convergent stereo angle. The 70mm film was fed from a double spool film supply (capacity 16,000 feet or 160 pounds) with one of two film webs going to each instrument through a system of drives, rollers, and clamps. The film was panoramically exposed through 70 degrees of lens cell angular rotation and then fed to a double spool takeup cassette in one of two SRVs. Simultaneous operation of both instruments was required for stereo photography. IMC was provided by a "nodding" cam proportional to the scan rate. The scan period was proportional to V/h , and a V/h programmer provided an in-flight adjustable sinusoidal voltage to assure the correct scan period. The J-3 camera subsystems contained the capability of panoramic geometry for mapping and charting.

The design goal for film utilization included the capability to accommodate infrared, high speed black and white, color, and ultra thin base (UTB) films. Although the film normally used was 3404 black and white, UTB was planned for use effective with the fifth system.

The main lens was a Petzval 24 inch focal length $f/3.5$ optical system. The exposure time could be varied in-flight by selecting one of four slit widths, plus a "failsafe" capability. The DISIC employed 35 mm film and dual side-looking 3 inch focal length, $f/2.8$ lenses. Index (cartographic) coverage was provided on 5 inch film with a 3 inch focal length, $f/4.5$ lens. Backup attitude information was provided by the horizon cameras with a 55mm focal length, $f/6.8$ lens system.

Time data was recorded by a silicon light pulser (solid state) driven by an electronic digital recording clock generator. Additional flight data was recorded by the conditioning of conventional pulsing or switching circuits. A recoverable tape recorder was used to provide the "center of format" times for each frame.

The command and control consisted of stored commands for on-off and recovery operations, and real time commands for system conditioning. Later J-3 configurations were equipped with a new command system utilizing a digital shift register for increased operational capability and flexibility. Telemetry consisted of commutated, multiplexed, and continuous data transmitted via the AGENA TM system. The J-3 system was designed to operate at 80 - 100 nautical miles and to produce ground resolutions of 5 - 6 feet.

The major improvements of the J-3 system were:

A. Constant Rotator Panoramic Camera

1. Removal of camera system oscillating members and reduction of error budget vibration components.
2. Improvement of V/h match from 5 percent to 1 percent.

CORONA HISTORY
Volume V

3. Proper camera cycling rates at altitudes down to 80 nautical miles (minimum J-1 altitude was 100 nautical miles).
4. Elimination of camera failure caused by film pulling out of rails (two such J-1 failures were experienced on-orbit).
5. Capability of handling ultra thin base (UTB) film. An increase of 50 percent in coverage at no increase in weight. Partial UTB loads were flown experimentally during early J-3 flights, and one complete flight (Mission 1105) was flown. However, this goal was never fully achieved because of film handling and the uncertainties of being able to consistently operate on-orbit with UTB .
6. Exposure control through variable slit selection.
7. On-orbit filter selection capability.
8. Capability of handling alternate film types and split film loads (color, infrared, etc.).
9. Improved lens performance.
10. Pan-geometry without effect on imagery (J-1 systems required IMC traces in the format area).

B. DISIC

1. Improved Terrain camera performance (increased focal length 1.5 inch to 3 inches).
2. Independent mapping capability.
3. Improved shutter reliability.
4. Removal of Stellar launch window restrictions (J-1 launch windows were governed by Stellar windows).
5. Elimination of Stellar camera flare (increased knee angle and improved baffle design).

C. All Systems

1. Removal of limited shelf life items.
2. Removal of items affecting R-1 readiness capabilities.
3. Reduced power requirements.

The payload structure consisted of a 60 inch diameter instrument barrel, DISIC conic section, fairing, pyro actuated doors, light tight boots, and miscellaneous operationally linked items. Both recovery systems were the General Electric MK V SRVs with sink valves, water seals, parachute, beacon, flashing light, and other standard equipment. The recovery battery was changed from a prelaunch activated battery to a pyro operated battery activated just prior to recovery. Storage characteristics of this battery allowed it to remain on the shelf up to three years before being utilized. The management organizational structure for the J-3 system contract is illustrated in Figure 2-14. Figure 2-15 presents a photograph of views of the camera system and the payload.

~~TOP SECRET~~

CORONA HISTORY
Volume V

THE J-3 SYSTEM

— Camera —

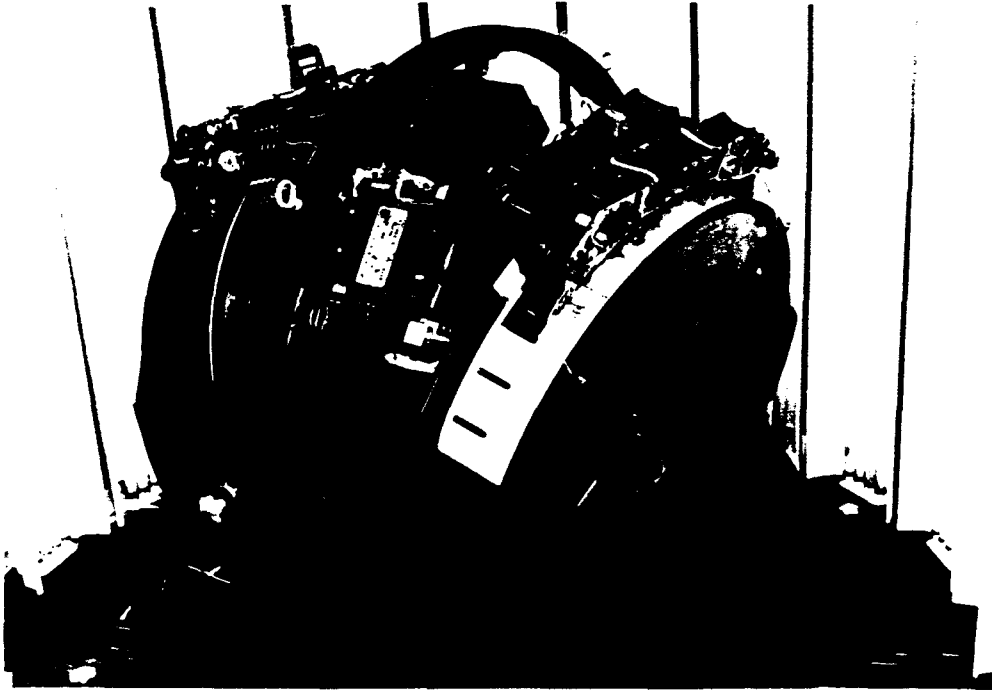

— Payload —



Figure 2-15

~~TOP SECRET~~

Handle via [REDACTED]
Controls Only

CORONA HISTORY
Volume V

Seventeen J-3 systems were purchased. Within these 17 was the first system in the CORONA Program to be built and dedicated for qualification testing. This system, QR-2, was later refurbished and flown. Of these 34 capsules, all were recovered except two (one system) which were lost when the THOR booster failed during the launch. Figure 2-16 is a schematic drawing of the J-3 payload.

These systems with lens improvements, better thermal and focus control, and a digital command system significantly improved the performance of the CORONA systems. This was substantiated by the Mission Information Potential (MIP) ratings derived by the National Photographic Intelligence Center (NPIC) which increased from 100 to 125.

The J-3 Program was scheduled for completion in 1970, but its replacement encountered many development problems and the Government had to resort to continuous "stretchouts" to provide the required reconnaissance coverage until the new program was fully operational. As a result, much of the hardware fabricated in 1967, 1968, and 1969 was "stretched" beyond its specified operational life. It was only through continuous testing and refurbishing that the hardware was made acceptable for flight. The final system (Mission 1117) performed on-orbit without an anomaly.

DUAL IMPROVED STELLAR INDEX CAMERA (DISIC) SUBSYSTEM (1964-1972)

The DISIC subsystem was designed to provide exposed film for use in precision geodetics and cartography and, in conjunction with the J-3 cameras, to aid in establishing vehicle attitude and precise location of reconnaissance points of interest. Figure 2-17 illustrates the configuration of the DISIC system. Figure 2-18 presents a photograph of the cross-section of a DISIC Conic with the RV installed. Table 2-1 lists the physical characteristics of the DISIC subsystem.

TABLE 2-1

SUMMARY OF THE PHYSICAL CHARACTERISTICS OF THE DISIC SUBSYSTEM

<u>Parameter</u>	<u>Terrain Camera</u>	<u>Stellar Camera</u>
Lens	3 inch Ikogon	3 inch Ikotar
Lens Aperture	f/4.5	f/2.8
Film Format	4.5 by 4.5 inches	1.25 diameter with flats
Angular Coverage	74 by 74 degrees	23½ degrees
Lens Distortion	30 microns (R) 5 microns (T)	15 microns (R) 5 microns (T)
Film Flattening	By glass plate	By glass plate

TABLE 2-1 (CONT'D)

SUMMARY OF THE PHYSICAL CHARACTERISTICS OF THE DISIC SUBSYSTEM

<u>Parameter</u>	<u>Terrain Camera</u>	<u>Stellar Camera</u>
Reseau	2.5mm spacing 10 microns maximum width	2.5mm spacing 10 microns maximum width
Reseau Illumination	Natural	Artificial
Natural Fiducials	1 set of four	1 set of four
Shutter Type	Rotary	Rotary
Selective Exposure Time	1/250 second 1/500 second	1.5 seconds
Cycle Period	9.375, 12.50, 15.675 and 18.75 seconds (last two not on CR-1 through CR-6)	3.125 seconds (Mode I) same as Terrain (Mode II)
Dual Stellar Operation	--	Simultaneous or by selection
Knee Angle	100 degrees	100 degrees
Data Recording	Time and serial number	Time and serial number
Film Type (normal)	3400	3401
Width	5 inch	35mm
Total Capacity	2,000 feet	2,000 feet
Metered Length	5 inches	3 inches

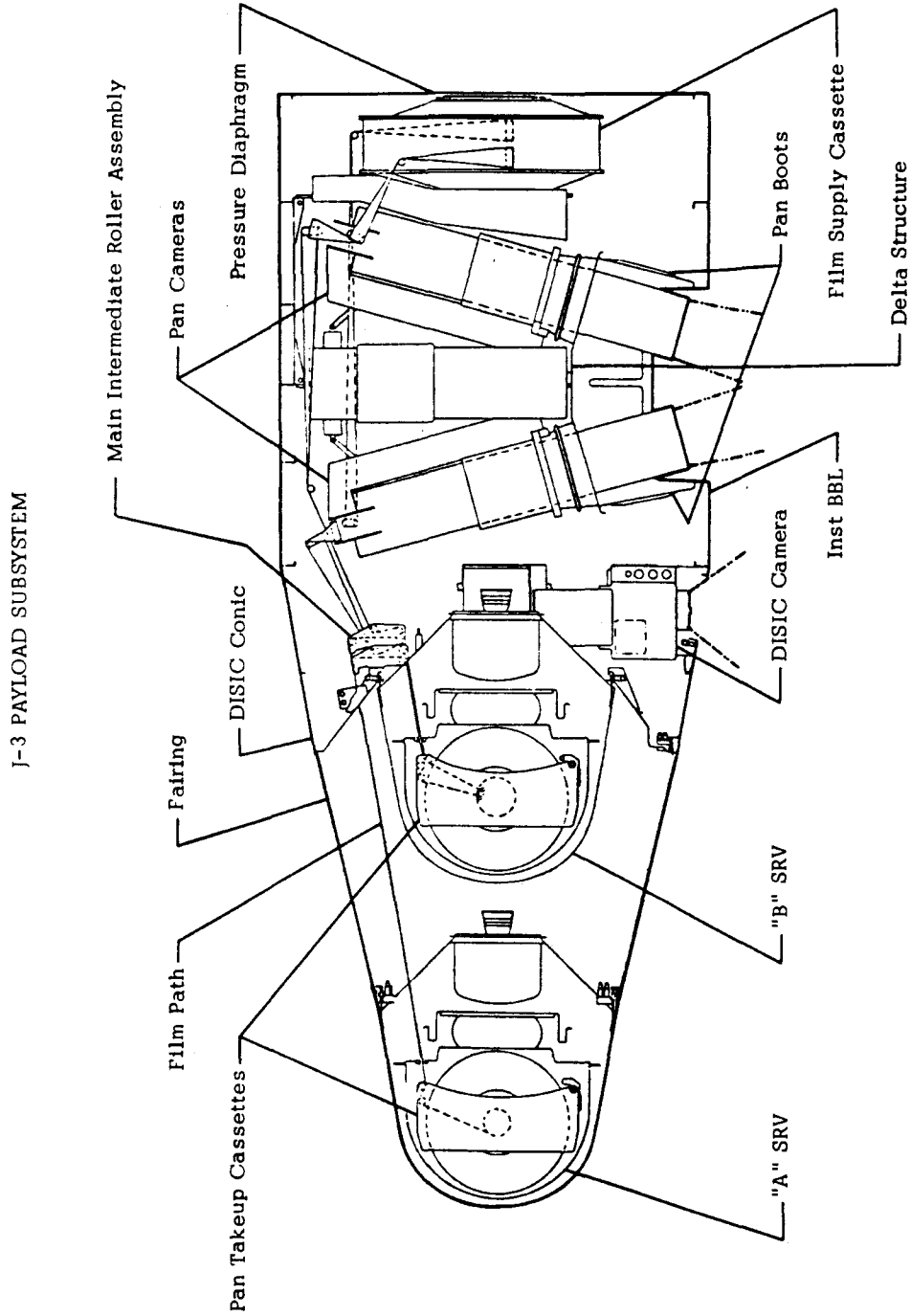

Figure 2-16

Handle via [REDACTED]
Controls Only

DISIC SYSTEM CONFIGURATION

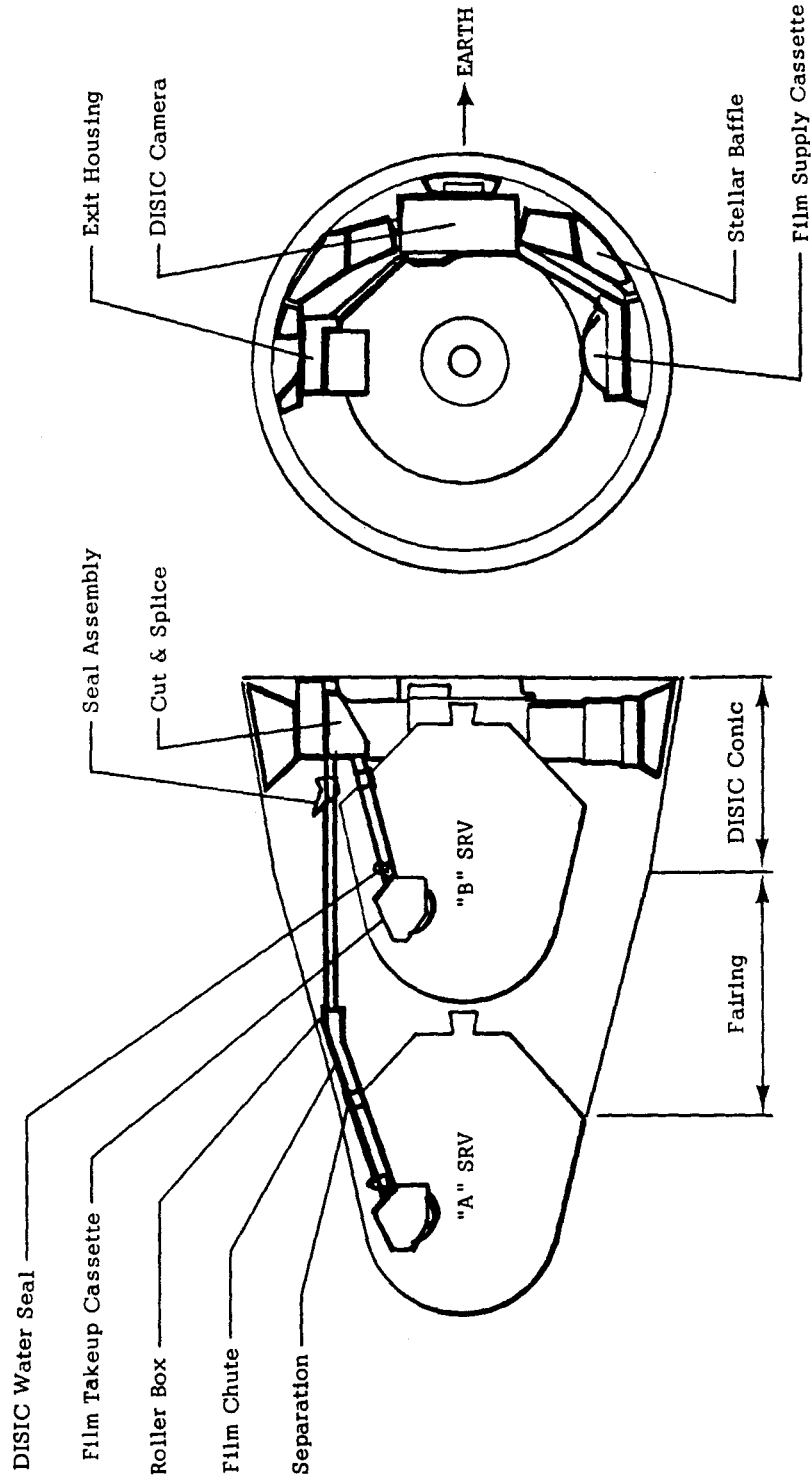
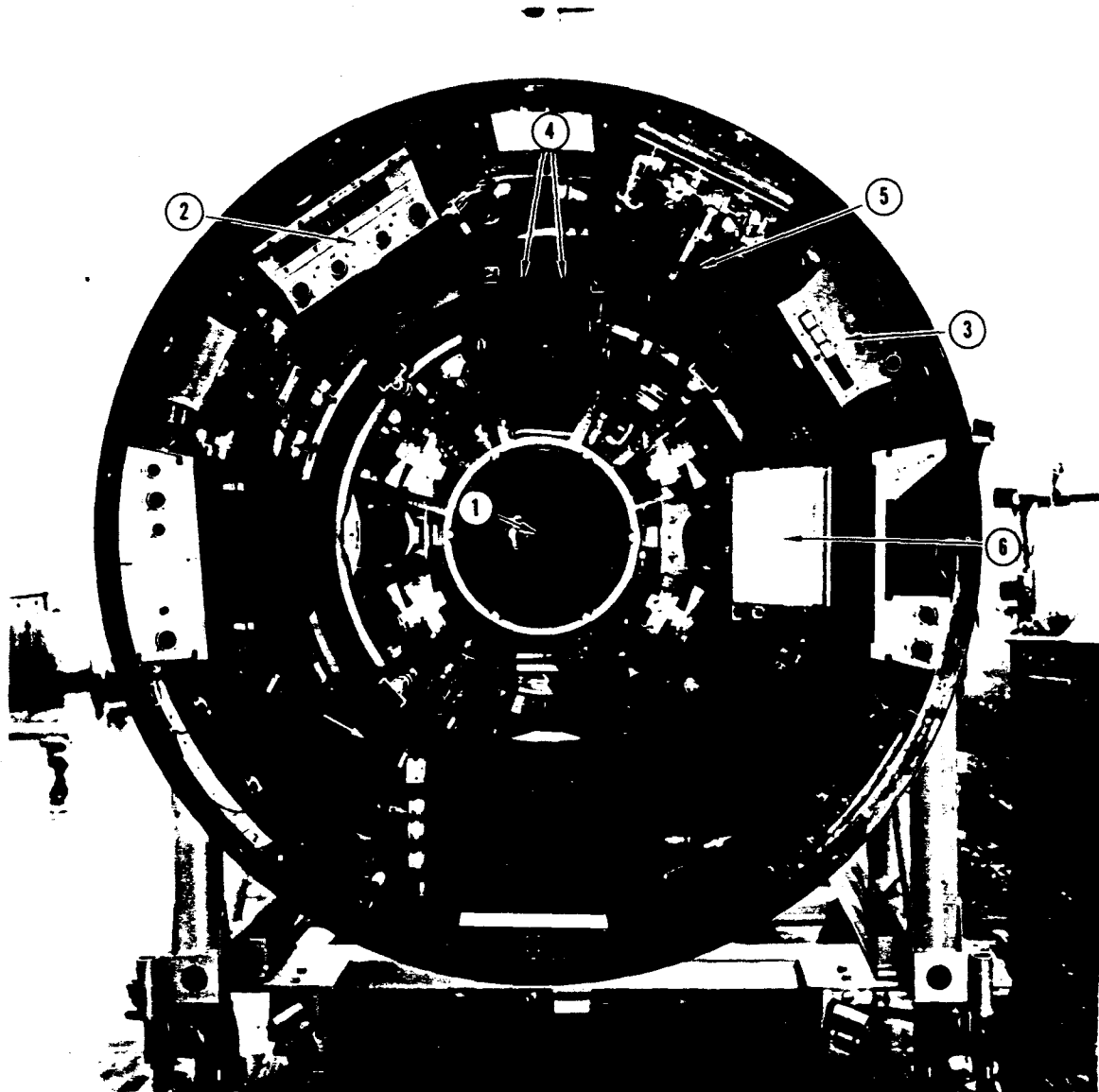

Figure 2-17

CROSS-SECTION OF DISIC CONIC WITH RV INSTALLED



1. SRV Retrorocket
2. Pyro J Box which Transfers "A" Segment-to-"B" Segment
3. Transfer Subsystem
4. Pan Camera 70mm Film Paths to Takeup Cassette
5. Two Bottle Pressure Makeup System
6. Cut and Splice Mechanism (TUNA)

Figure 2-18

~~TOP SECRET~~

SECURITY AND FACILITIES

~~TOP SECRET~~

Handle via 
Controls Only

***** NOTICE OF REMOVED PAGES *****

Pages 3-1 through 3-4 of CORONA, ARGON, LANYARD programmatic information are not provided because their full text remains classified.

CORONA HISTORY
Volume V

[REDACTED]

[REDACTED]

AP had trained and experienced manufacturing personnel and the facilities and equipment to perform manufacturing functions in support of the development and operation of satellite reconnaissance systems. The following is a list of the manufacturing capabilities at AP:

- A. Precision machining of detail parts including lathe turning, milling, drilling, grinding, polishing, etc.
- B. Fabrication of sheet metal parts including sawing, cutting, braking, rolling, bending, drilling, etc. Such items include various detail small parts, mounting brackets, doublers, stiffeners, shims, gussets, etc., and many mockup and special test parts.
- C. Molding and vacuum or hot forming rubber and plastic parts such as gaskets, seals, O-rings, etc.
- D. Bonding with various adhesives and epoxies many different types of materials including metal, wood, fiberglass, plastics, and rubber.
- E. Assembly and installation of parts into subassemblies and final assembly including such operations as fitting, riveting, bolting, match-drilling, etc.
- F. Assembly, maintenance, and repair of various types of tooling and AGE including dollies, console frames and enclosures, slings, handling fixtures, shop tooling, jigs, and fixtures.

***** NOTICE OF REMOVED PAGES *****

Pages 3-6 through 3-7 of CORONA, ARGON, LANYARD programmatic information are not provided because their full text remains classified.

CORONA HISTORY
Volume V

G. Sanding, polishing, sand-blasting, and other methods of preparation of material surfaces for application of finishes. Preparation, mixing, application, and curing of various finishing compounds including primers, paints, epoxies, alodyne, etc.

H. Fabrication of electrical junction boxes including all details such as terminal boards, modules, and internal cables.

I. Fabrication of cable harnesses to meet all flight, test, and AGE requirements using either solder type or taper pin connectors.

Figure 3-5 presents a series of photographs showing certain phases of these manufacturing capabilities at AP.

The AP test laboratories were equipped and staffed to perform the necessary functional and environmental tests on parts, components, subsystems, and systems. All tests required to qualify equipment for satellite application were performed at AP except for the System Thermal Vacuum Tests which were conducted in the large vacuum chambers at Lockheed's main plant in Sunnyvale. Thermal vacuum testing was first introduced into the Space Industry by the CORONA Program. This method has now become a standard in the testing procedures used for all satellite reconnaissance payload subsystems. Figure 3-6 shows a series of photographs which depict: (1) the first vacuum chamber in Boston which was used to conduct early tests on the dry leaves and CORONA electrostatic marking problems; (2) the High Altitude Thermal Simulation (HATS) Chamber which was used for testing "C," "A," and "M" systems; (3) the Thermal Altitude Simulation Chamber (TASC) which was moved from Boston to Sunnyvale and used for system level testing of the "M," "L," and extensively on the J-1 Programs; and (4) the High Vacuum Orbital Simulation (HIVOS) Chamber which was used for testing J-1 and J-3 systems. Figures 3-7 and 3-8 present photographs of different phases of some of the early developmental testing. Figure 3-9 shows photographs of some of the clean room areas with associated equipment used to perform photographic tests. Figure 3-10 shows a series of film tension tests checking from the spool to the film to the splices. Figure 3-11 is a photograph of a J-3 system going through collimation testing. The following is a list of the major test equipment and facilities utilized at AP:

A. Electrodynamic Shaker

Force Output: 21,500 pounds maximum
Frequency Range: 5 - 2,000 cps
Maximum Stroke: .8 inch peak-to-peak

B. Slip Table

Size: 68 inches by 68 inches
Oil Feed: Pressurized with filter and 2 gallon reservoir

ADVANCED PROJECTS MANUFACTURING CAPABILITIES



Machine Shop

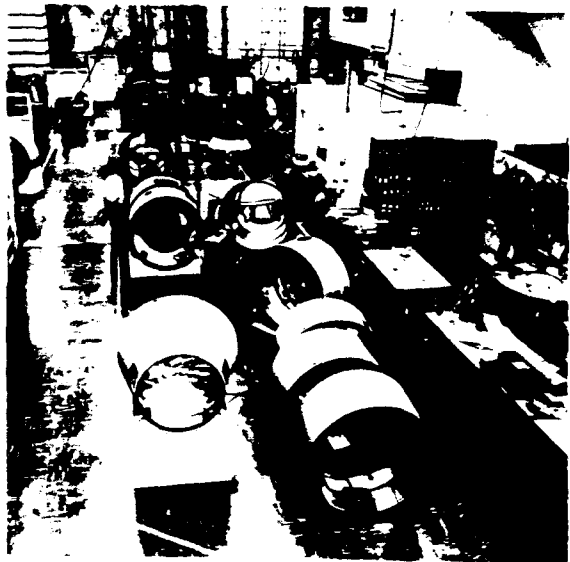

Camera Systems Modification



Manufacturing Electric Boxes and Harnesses



Harness Layout and Fabrication

Figure 3-5

THERMAL VACUUM TESTING



"M" System Going into High Altitude Thermal Simulation Chamber at Sunnyvale

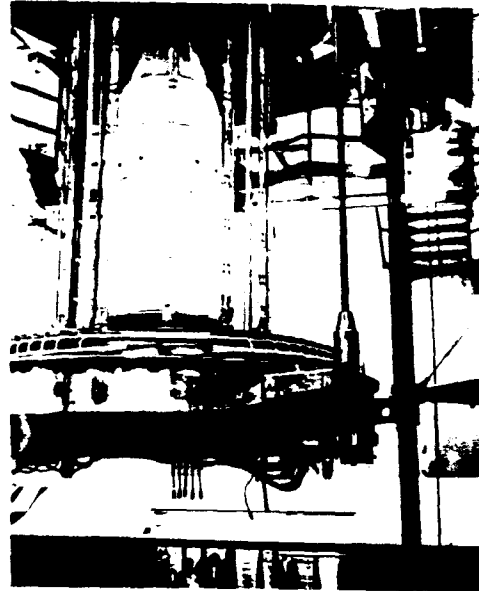

J-3 System Going into High Vacuum Orbital Simulation Chamber at Sunnyvale

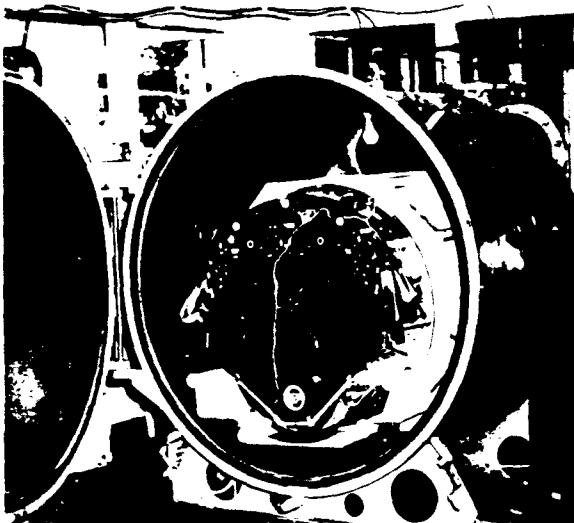

"C" System in Vacuum Chamber at Boston

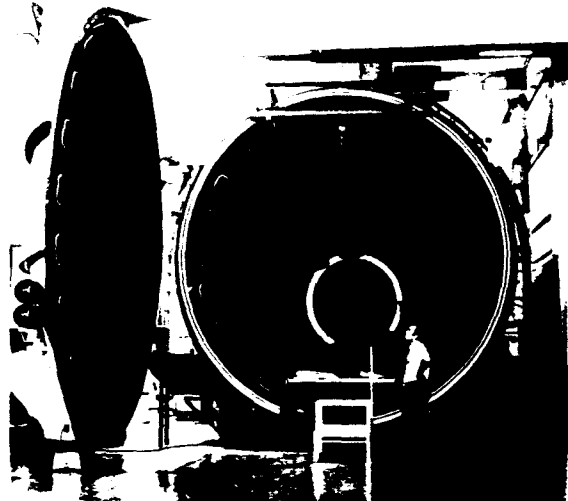

Thermal Altitude Simulation Chamber at Sunnyvale

Figure 3-6

DEVELOPMENT TESTING



1958 - Ascent Heating Test



Vibration Test Area

Figure 3-7

DEVELOPMENT TESTING

— Camera Door Blow-off Test —



Prepares J-1
for Blow-off Test

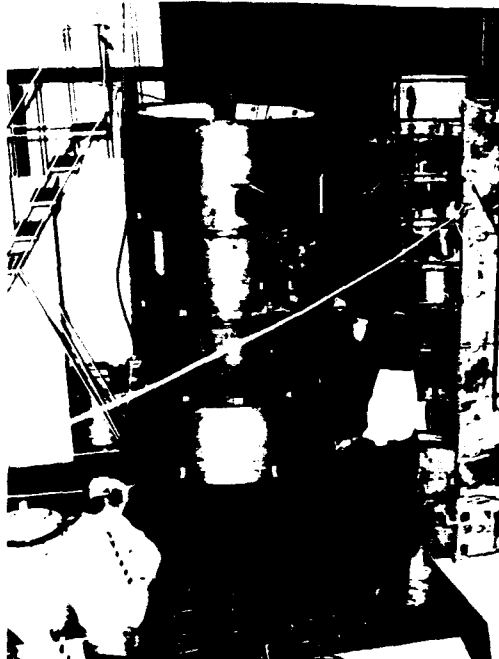

Inspect Door Installation



Successful Door Ejection
Observed by [REDACTED]

Figure 3-8

PHOTO-OPTICAL TESTS

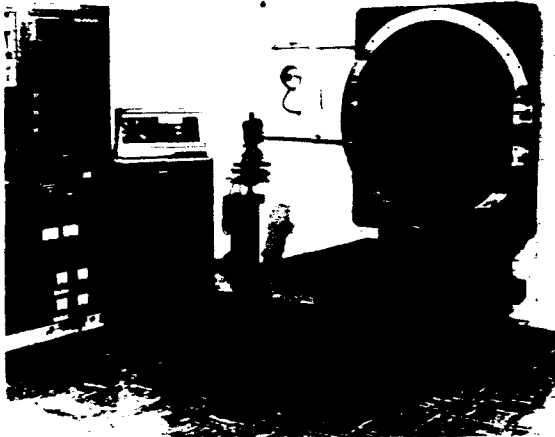

Clean Room Collimator and Theodolites
Used to Test "C" Systems

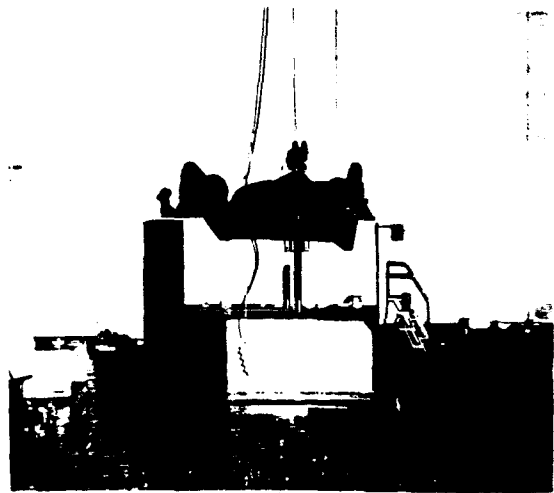

Clean Room and Block Used to Test
"M" and J-1 Systems

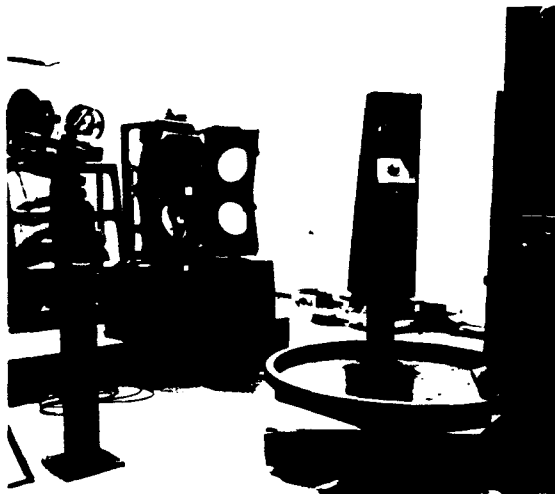

Clean Room and Isolation Block Used
in Collimation Testing of J-3 System



Pressure Makeup Units Used to
Solve Electrostatic Marking Problem

Figure 3-9

FILM/SPLICE TENSION AND STRENGTH TESTS

— Testing Film Tension/Strength from Spool —

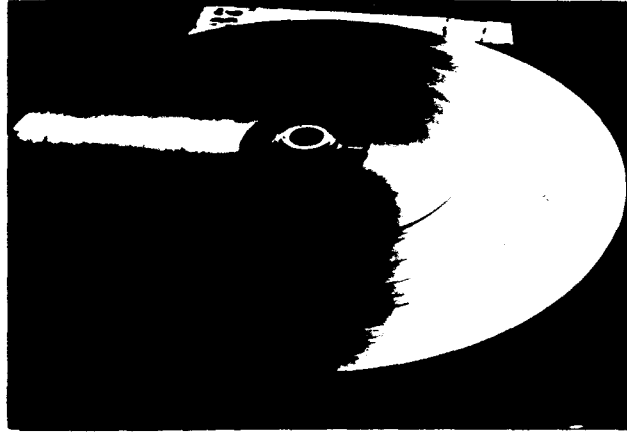

— Different Tests to Examine Strength of Film Splices —

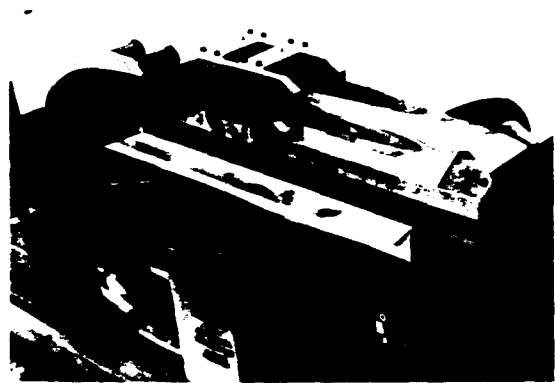
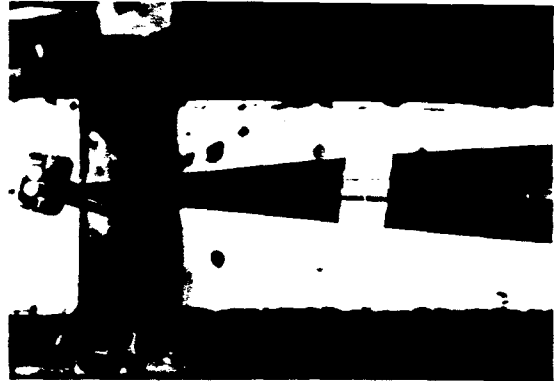

Figure 3-10

A J-3 SYSTEM ON THE COLLIMATION BLOCK



Figure 3-11

C. Altitude - Thermal Chamber

[REDACTED]

Temperature Range: -100 to +250°F

Altitude Range: Ambient to 3.7 by 10⁻⁶ mm Hg

Chamber Sizes: Thermal: 48 inches by 48 inches by 48 inches

Altitude: 39.5 inches diameter x 36 inches long

NOTE: The Altitude Chamber fits inside the Thermal Chamber.

D. Pendulum Shock Tester

Specimen Size: 20 inches by 20 inches by 12 inches

Specimen Weight: 15 pounds

g Level: 5 to 50g, 0 to Peak

1/2 sine wave only

1 to 40 milliseconds duration

E. Temperature Chamber

Size: 20 inches by 15 inches by 11.5 inches

Temperature Range: -100°F to +500°F

Stability: ± 1°F

F. Vacuum Chambers (2 each)

Sizes: 13.5 inches diameter by 24 inches high

13.5 inches diameter by 14 inches high

14 inches diameter by 14 inches high

Range: Atmosphere to 10⁻⁴ Torr

There were Thermal Altitude Simulators capable of accepting complete payload systems and subjecting them to orbital environment, and numerous types of supportive equipment (transducers, recorders, test instruments, etc.).

The AP photographic laboratories were equipped and staffed to perform all functions essential for the support of the development and preflight operation of satellite photographic reconnaissance systems.

Reconnaissance imagery was processed and duplicated [REDACTED]

Air Force Special Projects Production Facility (AFSPPF), Westover Air Force Base, Massachusetts.

A basic factory-to-launch philosophy was followed to reduce unnecessary handling operations and eliminate redundant assembly/disassembly testing, in addition to reducing the response time to customer launch requirements. Criteria for component and subsystem tests were designed to obtain maximum confidence

CORONA HISTORY
Volume V

of each item prior to its integration into the system. The test sequence was governed by the objectives of the factory-to-launch concept wherein acceptance tests, component tests, subsystem tests, system integration, system tests, environmental tests, and prelaunch tests were performed to prepare the payload system at the factory for shipping and mating with the launch vehicle without additional testing. Therefore, each associate contractor established a logical sequence of testing from component acceptance through subsystem assembly and functional verification. Figures 3-12 presents a milestone flow chart of the factory-to-launch cycle used at the AP Facility. Figure 3-13 is a series of photographs depicting the factory-to-launch subsystem testing concept. Figure 3-14 shows some of the handling procedures used in the mating of a payload subsystem at the launch pad.

Hardware furnished by AP received similar treatment in that component testing included those tests required to assure the item was ready for system integration. Structural components were inspected for conformance to drawings, specifications, and workmanship. Electrical cabling was subjected to continuity and isolation DITMO testing. Black box components were functionally tested by automatic testing devices (CTI) to verify proper wiring and mode responses.

Subsystem testing was accomplished on all GFE equipment after arrival at AP. Each subsystem was inspected for compliance with shipping conditions, configuration, and interface requirements. All structural wiring installations were verified by CTI testing.

System integration provided for the installation of all GFE and AP subsystems into the flight structure. At this point, the compatibility of all subsystems was checked and verified. Upon completion of the compatibility test, the payload system was then subjected to environmental testing which included vibration and thermal/altitude simulation tests. The Vibration Test consisted of subjecting the system to low level vibration to determine manufacturing and assembling integrity. The payload system was operated prior to and after the Vibration Test to insure acceptable performance. The Thermal/Altitude Test provided a complete mission simulation for payload system operations.

At the start of prelaunch testing, the configurations of all subsystems in the structure were examined and verified with the drawing list to insure compliance with mission requirements. As testing progressed, continuity of subsystem wiring was verified by testing all pins on the AGENA payload interface connectors after the flight film had been loaded in the supply cassette. The SRV, DISIC, panoramic cameras, and associated subsystems were operated during this testing phase to insure proper system performance.

ADVANCED PROJECTS FACTORY-TO-LAUNCH FLOW CHART

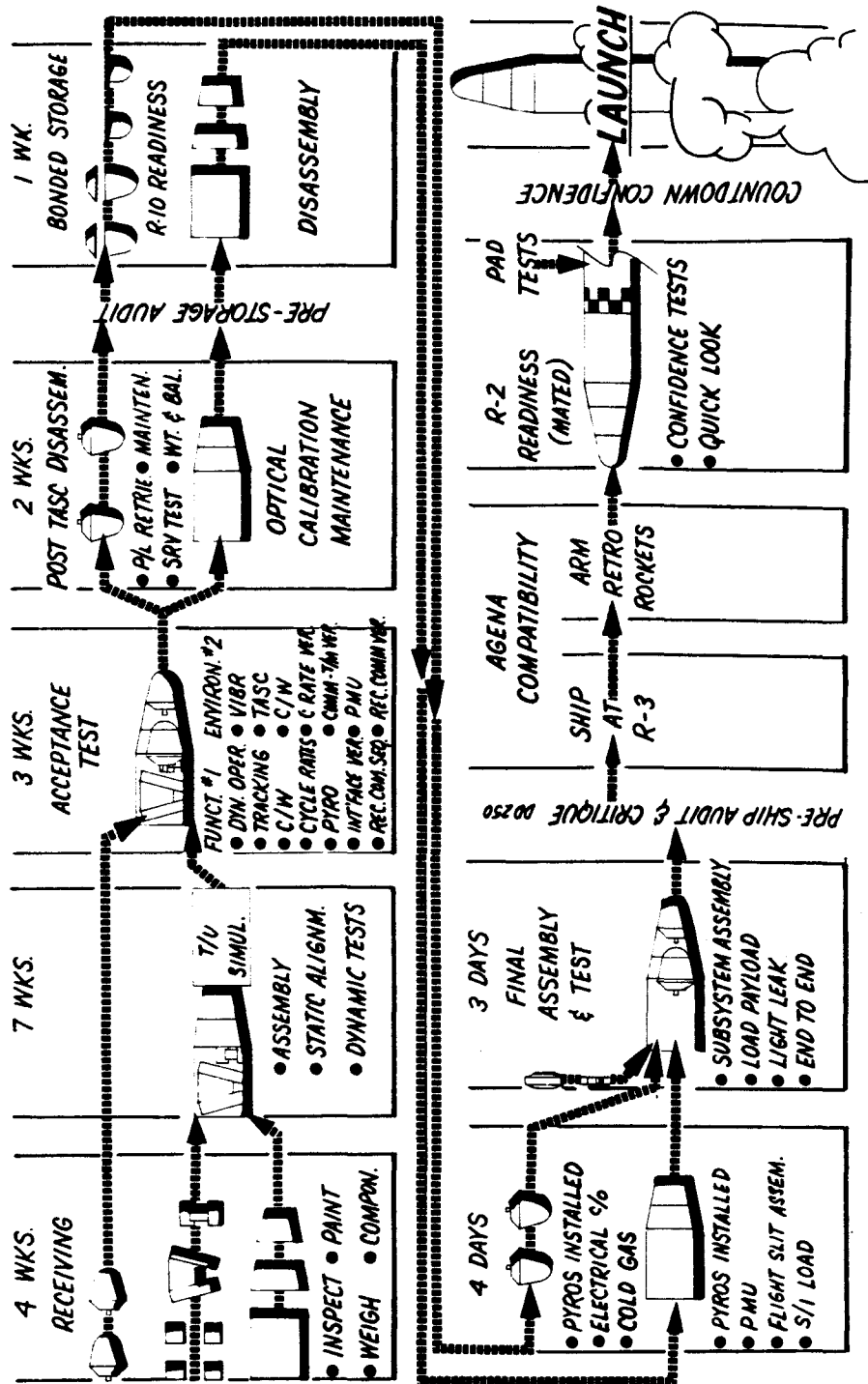
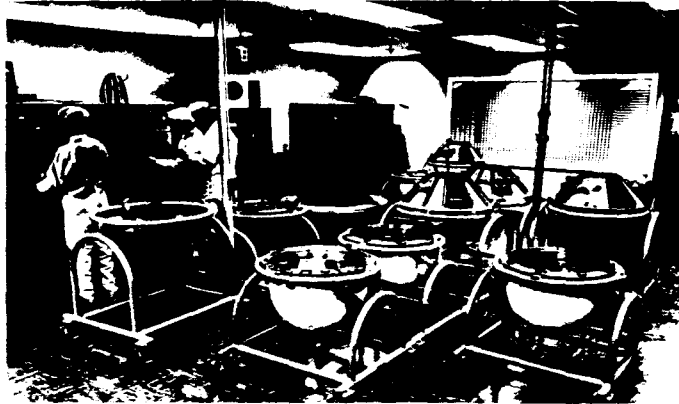

Figure 3-12

FACTORY-TO-LAUNCH TEST CONCEPT



Camera Testing



SRV Testing

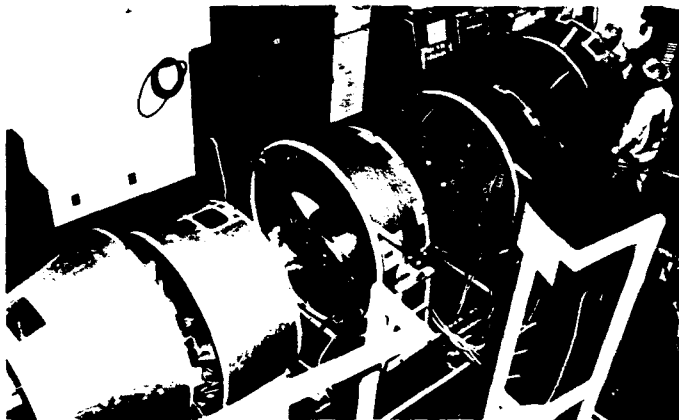

System Testing

Figure 3-13

J-1 PAYLOAD SYSTEM MATING AT LAUNCH PAD

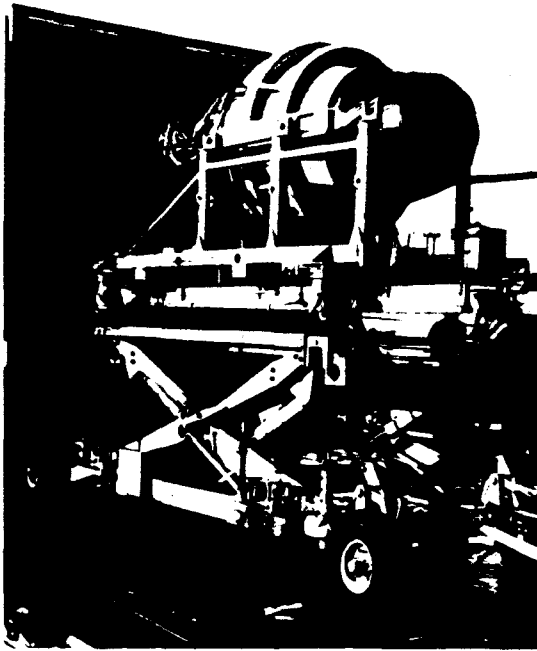

From Truck to Handling Dolly

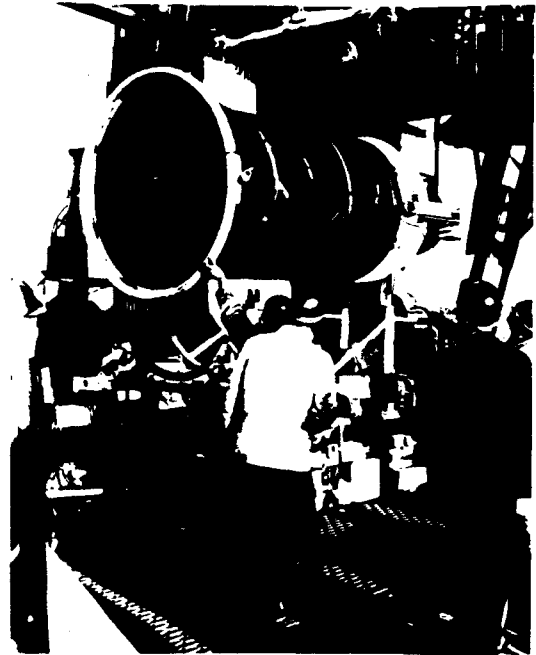

Handling Rings and Slings Attached



Securing/Uprighting Payload

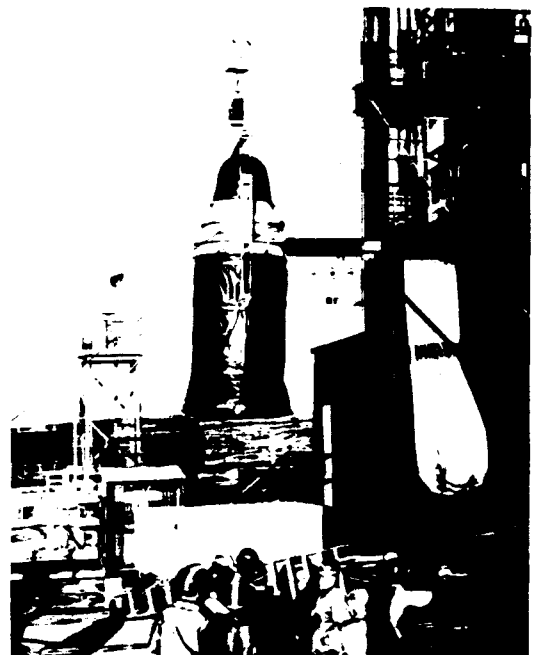

Hoisting Payload to Mate

Figure 3-14

~~TOP SECRET~~

CORONA HISTORY
Volume V

After completion of the prelaunch tests, the system was shipped to VAFB. Upon arrival at VAFB, the payload was subjected to receiving and post-mate confidence tests to assure no in-transit deviation had been introduced in the trip from the AP Facility. The Receiving Test included a complete System Functional Test and Final Light Leak Check before mating to the AGENA. The Post-Mate Confidence Test was conducted to verify the launch readiness of the AGENA payload system. Operational checks were performed on the main payload system, subsystems, and all ancillary equipment to insure operational readiness. The Final Confidence Test was performed on launch day to verify camera system operation and SRV functions prior to lift-off.

~~TOP SECRET~~

Handle via 
Controls Only

~~TOP SECRET~~

THE AGENA VEHICLE
AND
THE THOR BOOSTER

~~TOP SECRET~~

Handle via 
Controls Only

~~TOP SECRET~~

CORONA HISTORY
Volume V

SECTION IV

THE AGENA VEHICLE AND THE THOR BOOSTER

The combination of the AGENA satellite vehicle (SV) and the THOR booster vehicle (BV) had a phenomenal record of success over the lifetime of the CORONA Program. The AGENA evolved through three series (A, B, and D) of upgrading. The first booster was the basic THOR. In early 1963, the boosting capacity was increased by the addition of a cluster of small solid propellant rockets and the BV then became known as the thrust augmented THOR or TAT. From 1966 to 1972 the THORAD or long tank THOR was utilized as the booster.

AGENA SATELLITE VEHICLE

The AGENA vehicles used during the CORONA Program included models designated as A, B, and D. Major subsystems of the AGENA SV included:

- A. Forward payload and recovery capsule(s).
- B. A guidance and attitude control system which remained essentially a three-axis gyro system (Inertial Reference Package) with correction inputs from an horizon scanner and later by a pair of horizon sensors. Attitude correction was made by cold gas valve firings. A "Lifeboat" system was developed consisting of earth sensing magnetometers, a sequence timer, and a separate cold gas system which provided a backup attitude capture/control recovery capability. Preprogrammed timers provided event sequencing for ascent, recovery, and other special re-orientation sequences.
- C. An electrical system which consisted of several types of batteries varying from as many as 61 H batteries with a 490 ampere hours per battery capacity. The later electrical systems were a two battery plus solar array system. Regulated power supplies were utilized for guidance equipment, telemetry, etc.
- D. The propulsion system utilized a Bell rocket engine for orbit injection. This engine delivered approximately 16,000 pounds thrust utilizing UDMH fuel and IRFNA as an oxidizer.
- E. Telemetry (TM) was FM/FM with one to four links sending data over VHF. TM was transmitted over S-band in the later series. The original command system was a single deck, motor driven, orbital programmer (13 preprogrammed commands) and a 4 tone/6 command S-band beacon. The command system evolved to a 4 deck programmer (52 preprogrammed commands), a 32 command flight loadable storage register, redundant real time (UHF and S-band) 32 command system, plus 7 secure commands. Terms such as ANALOG, ZOMBIE, ZEKE, ZORO, UNCLE, and SILO were some of the various command systems utilized during program evolution.

The following is a summary of the events which occurred on the launches from the three AGENA model series:

~~TOP SECRET~~

CORONA HISTORY
Volume V

A. AGENA A Series (15 vehicles)

1. The first launch (Vehicle 1022) on 28 February 1959, was believed to have achieved orbit; however, no telemetry data was recovered to confirm orbital success.

2. On the second launch, the vehicle remained stable for slightly over 24 hours but due to a timing malfunction the ejection sequence was initiated too early causing the capsule to enter and impact far from the scheduled recovery area near Hawaii. It is suspect whether this capsule was ever recovered, but one thing is certain, it was not recovered by the United States.

3. Vehicles three through twelve suffered five launch failures; the remaining five vehicles averaged approximately one day of stable orbit operation, but none of the capsules were successfully recovered.

4. Vehicle 1057 achieved orbit on 10 August 1960. After a one day operation the capsule was successfully retrieved from the ocean. This marked the first recovery of a re-entry capsule from an orbiting spacecraft.

5. The fourteenth launch (Vehicle 1056) was on 18 August 1960. The vehicle experienced stability problems, but the re-entry was successful and the capsule caught for the first in-air recovery. This was the famous Mission 9009, the world's first satellite photographic reconnaissance mission.

6. The final Series A vehicle, launched on 13 September 1960, orbited successfully and capsule re-entry occurred. However, the capsule landed approximately 500 nautical miles from the predicted impact point and sank because the recovery forces did not reach the capsule within its designed floating time.

B. AGENA B Series (36 vehicles)

1. The first launch, Flight Test Vehicle (FTV) 1061, on 26 October 1960 failed to achieve orbit due to a timing malfunction.

2. FTV 1062 was launched on 12 November 1960 and both orbital operation and air recovery were successful.

3. The remaining 34 vehicles were launched between 7 December 1960 and 24 November 1962. Although there were numerous orbital failures on the earlier flights, reliability and mission duration gradually improved. The final vehicle of the series, Mission 9048, successfully completed a five day mission. Two vehicles within this series (1101 and 1102) were flown for radiation monitoring and configured without camera systems or recoverable capsules. Vehicle 1102 demonstrated the feasibility of an engine orbital restart.

4. In summary, a total of 20 recoveries of the B Series were successful, seventeen of these were recovered aurally. Vehicle 1128, launched on 29 May 1962, carried the first "Lifeboat" emergency recovery system.

CORONA HISTORY
Volume V

C. AGENA D Series (94 vehicles)

1. The first launch, FTV 1151, on 27 June 1962 resulted in successful recovery.
2. The first utilization of the TAT booster was Vehicle 1159 on 28 February 1963. However, the third solid rocket on the THOR (370) failed to separate and destruction occurred after 100 seconds.
3. The first vehicle to carry two recovery capsules was FTV 1162, launched on 24 August 1963.
4. Vehicle 1176, launched on 4 June 1964, was the first dual recovery vehicle with a deactivate/reactivate capability. This capability provided a method of extending the duration of a mission. The deactivate/reactivate system was used infrequently and was deleted in later series vehicles.
5. Vehicle 1603, launched on 21 August 1964, carried the first orbit adjust (O/A) system. This system, utilizing up to twelve 2,000 pounds/second or 3,000 pounds/second rockets for orbit corrections, was operationally utilized for the first time on Mission 1033 (launched on 23 May 1966).
6. Vehicle 1615, launched on 18 May 1965, was the first program vehicle to be oriented nose forward in-orbit.
7. AGENA 1631 and THOR 506 were launched on 9 August 1966, the first launch of the long tank THORAD booster. This mission (1036) was 100 percent successful.
8. Two vehicles procured and accountable to this series (1401 and 1602) were not actually flown as a part of the CORONA Program. They were flown as special research payloads without camera systems.
9. Program vehicle and recovery system reliability improved significantly. In fact, the final 96 capsules ejected from orbiting vehicles between 23 May 1965 and 31 May 1972 were successfully recovered without a single loss. This represented a span of over seven years' operation without a recovery failure.
10. In summary, 85 of the 92 vehicles in the CORONA AGENA D Series successfully attained orbit. Seven vehicles failed to achieve orbit for the following reasons: FTVs 1159, 1171, and 1659 were attributed to a THOR booster malfunction; and FTVs 1164, 1175, 1411, and 1625 were AGENA malfunctions. The three TAT failures (370, 400, and 537) were the only booster problems in 145 CORONA launches, and two of those (370 and 400) represented the development of the new technique of solid rocket thrust augmentation. Between November 1963 and February 1971 there were 67 consecutive successful launches by the Douglas launch team.

Figure 4-1 presents a diagram of the original AGENA. Figure 4-2 illustrates an artist's concept of the AGENA D model. Figures 4-3 and 4-4 are photographs of different views of an actual AGENA D vehicle. Table 4-1 presents a summary of the nominal weight of the AGENA at different stages of its flight cycle.

TABLE 4-1

NOMINAL AGENA WEIGHT SUMMARY

<u>Item</u>	<u>Weight (pounds)</u>	<u>Total Weight (pounds)</u>
1. Weight Empty (including three gas bottles and DMU supports)		2,005
Propellants	13,540	
Helium	1	
Attitude Control gas (-3 mix)	115	
Except attitude control gas - L/B (-3mix)	16	
IM batteries	744	
DMU rockets	185	
2. Gross Weight Without Payloads		16,606
Less adapter and attach	408	
Less retrorockets	10	
Less destruct system	6	
Less horizon sensor fairings	7	
Less attitude control gas	1	
3. Ignition Weight Without Payloads		16,174
Less propellants	13,392	
Less engine start change	1	
Less attitude control gas	3	
4. Burnout Weight		2,778
Less residual propellants	48	
Less helium	1	
Propellant margin	100	
5. Weight On-Orbit with Gas but Without Payload		2,629
Less remaining attitude control gas	111	
Less remaining L/B gas	16	
6. Empty Weight On-Orbit Without Gas, Without Payload, 12 DMU Rockets and W6 IH Batteries		2,502

ORIGINAL AGENA SATELLITE VEHICLE

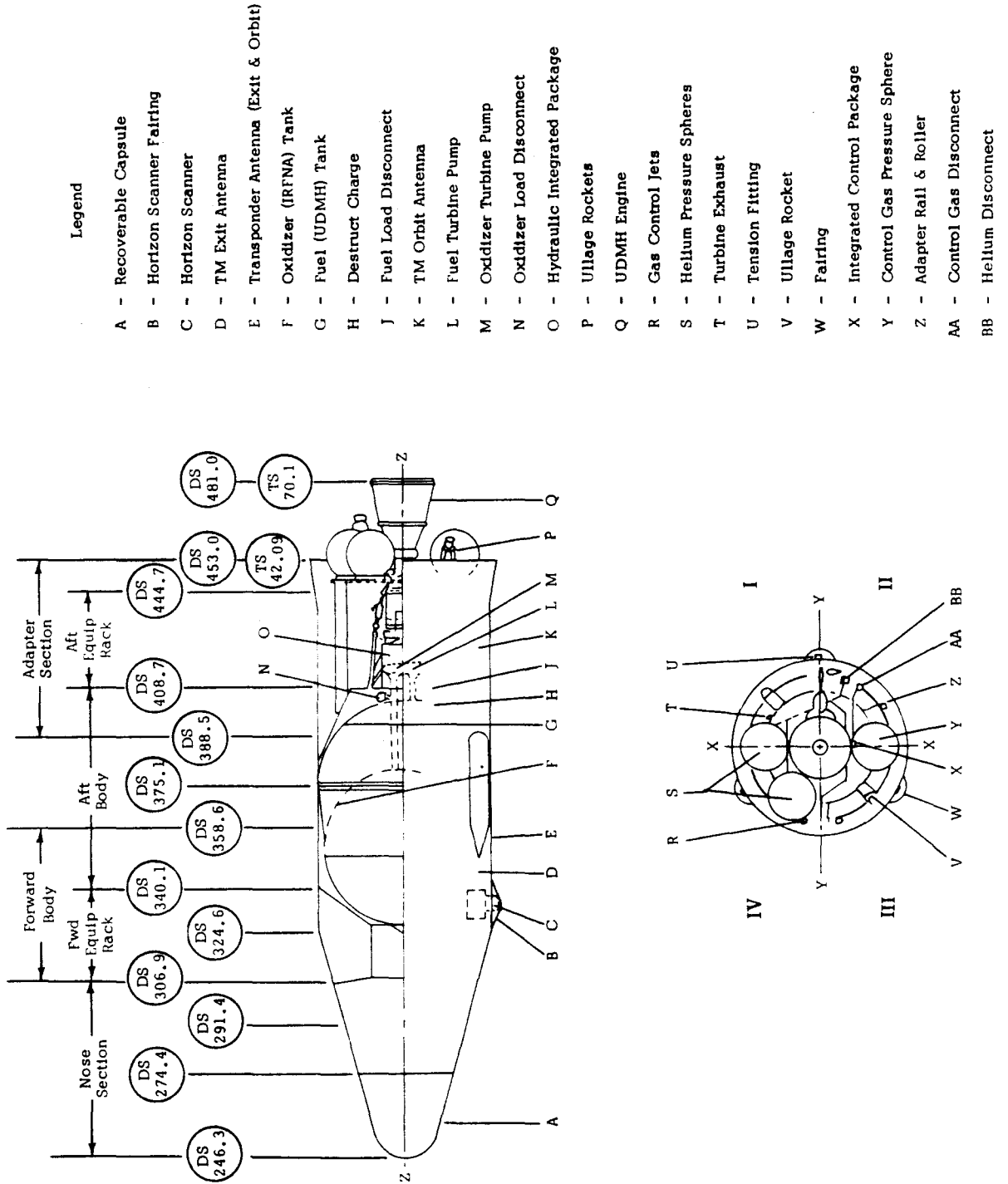

Figure 4-1

Handle via [redacted]
Controls Only

ARTIST'S VIEW OF THE AGENA D SATELLITE VEHICLE

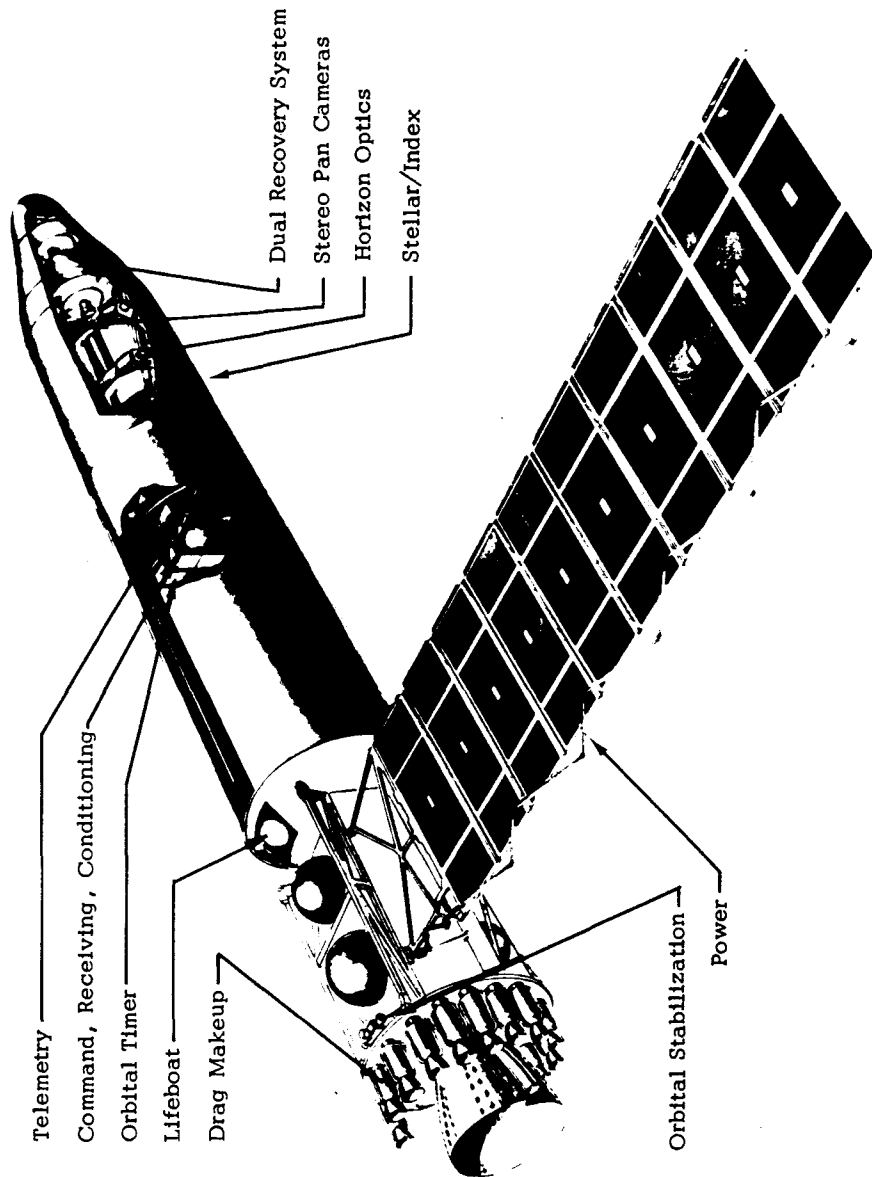

Figure 4-2

THE AGENA D SATELLITE VEHICLE

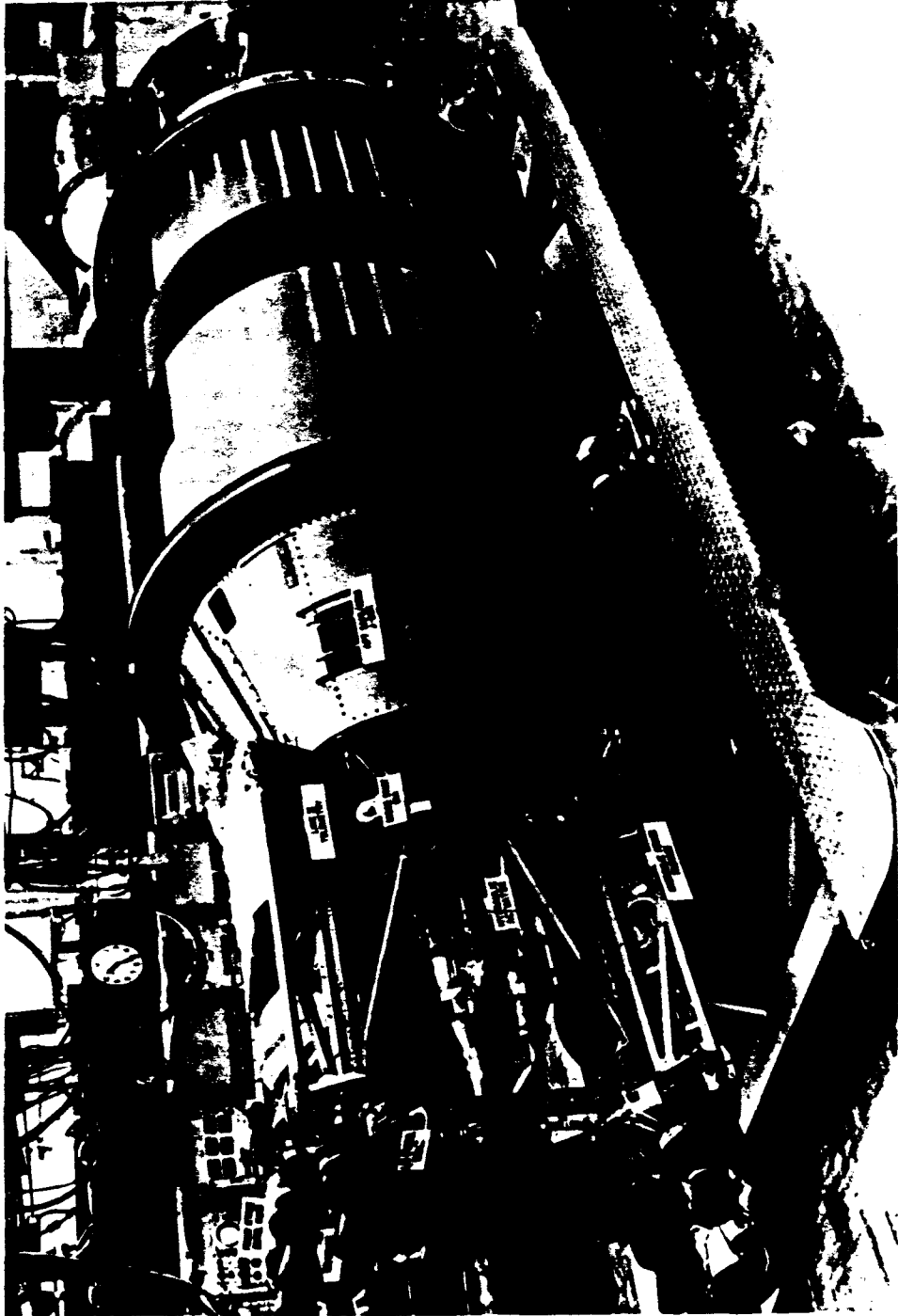
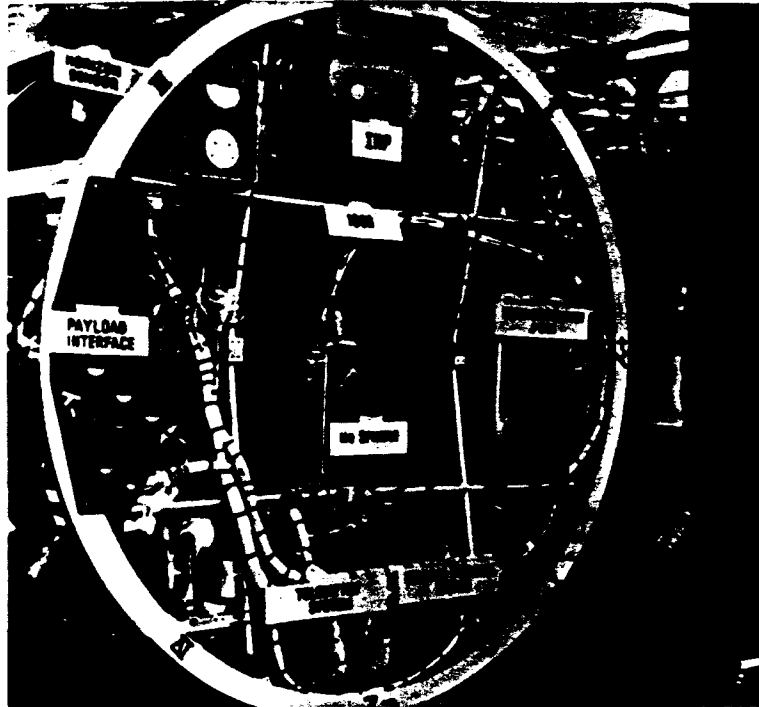

Figure 4-3

FORWARD AND AFT RACKS OF THE AGENA D SATELLITE VEHICLE

— Forward Rack —



— Aft Rack —

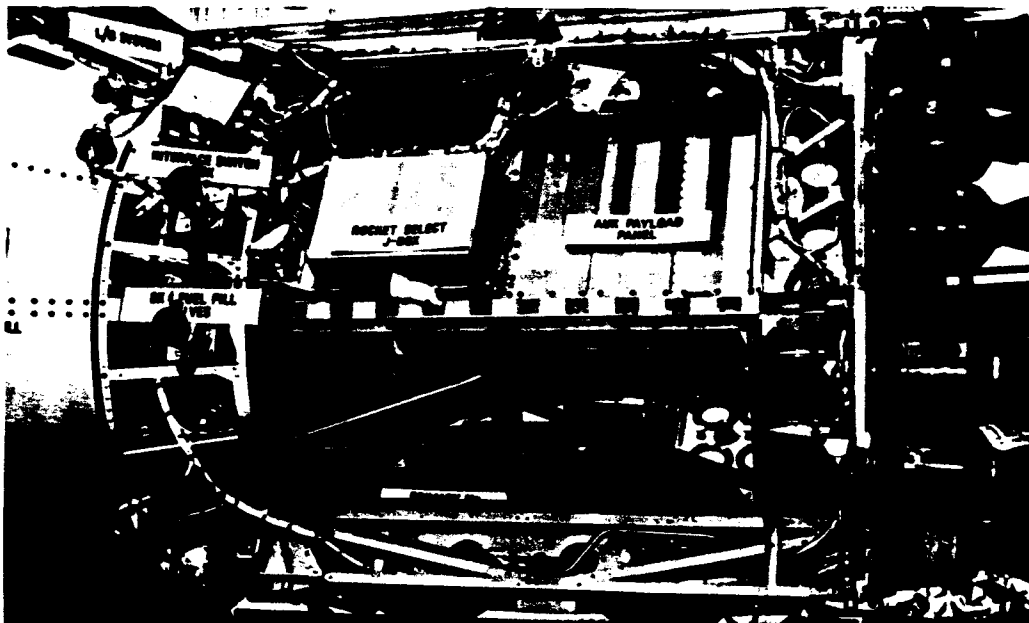

Figure 4-4

Handle via [redacted]
Controls Only

THOR BOOSTER VEHICLE

Three versions of the highly reliable THOR booster were used during the life of the CORONA Program. The basic THOR had been developed as a medium range ballistic missile (MRBM) and was converted for CORONA use as a spare booster. The thrust augmented THOR (TAT) was introduced by Douglas in 1963 to provide added on-orbit capability for the growing CORONA payloads. The first TAT was launched on 28 February 1963 and had to be destroyed when the third TAT booster failed to separate. The THORAD or long tank THOR was developed specifically for the CORONA J-3 Program, but was in fact used by both the J-1 and J-3 systems from 1966 until 1972. Table 4-2 lists the performance characteristics of the THORAD booster.

TABLE 4-2

THORAD PROPULSION PERFORMANCE CHARACTERISTICS

<u>Item</u>	<u>Performance Characteristic</u>
1. Liquid Propellant Vernier Engine	
Fuel	RJ-1
Oxidizer	Liquid oxygen
Thrust	176,962 pounds
Mixture ratio	2.06 ± 2 percent
Specific impulse	286.6 seconds
Propellant utilization (min)	99.8 percent
Total impulse	41,737,441 pound-seconds
2. Three Solid Engines (each)	
Axial specific impulse	265.3
Thrust (nominal during web-burn)	56,919 pounds
Total impulse	2,138,447 pound-seconds
Operational temperature range	10 to 110°F
Main engine burn time	219 seconds
Vernier engine burn time	228 seconds
Solid motor burn time	37 seconds
Reliability	0.98

Figure 4-5 illustrates the configurations of the three versions of the THOR. Figure 4-6 shows a diagram of the major components of the combined satellite/booster launch vehicle.

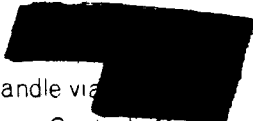
Handle via 
Controls Only

BOOSTER CONFIGURATIONS

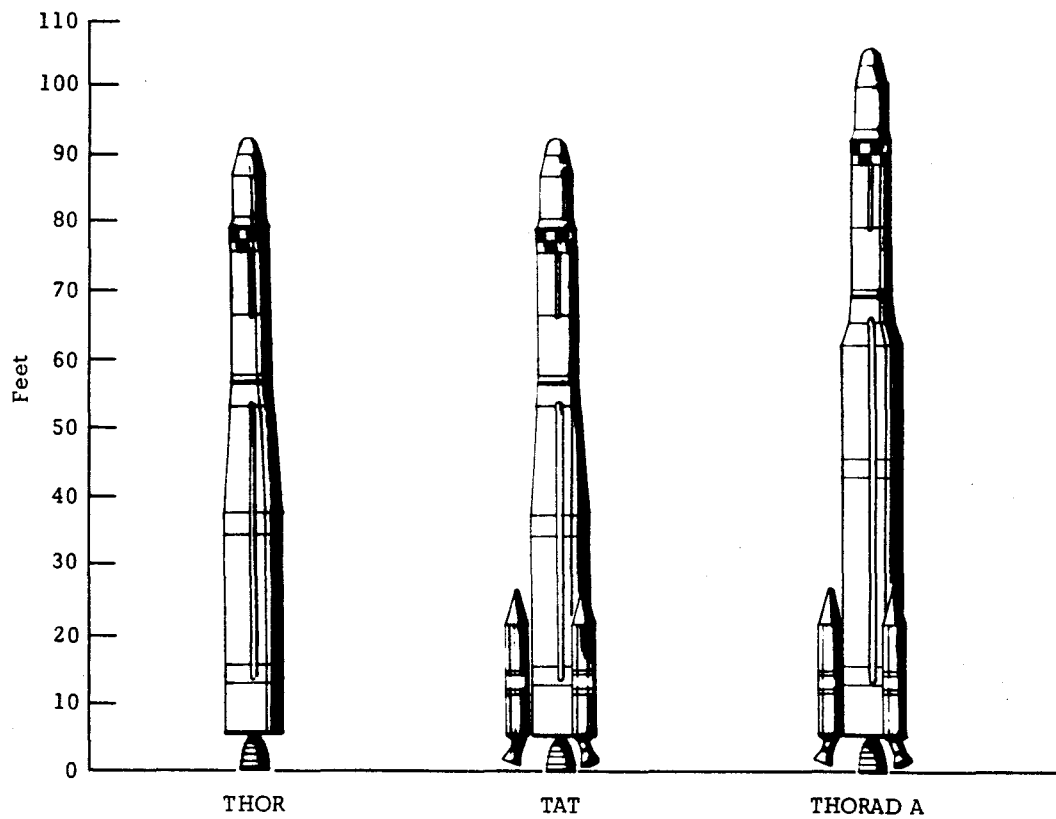

Figure 4-5

THE MAJOR COMPONENTS OF THE LAUNCH VEHICLE

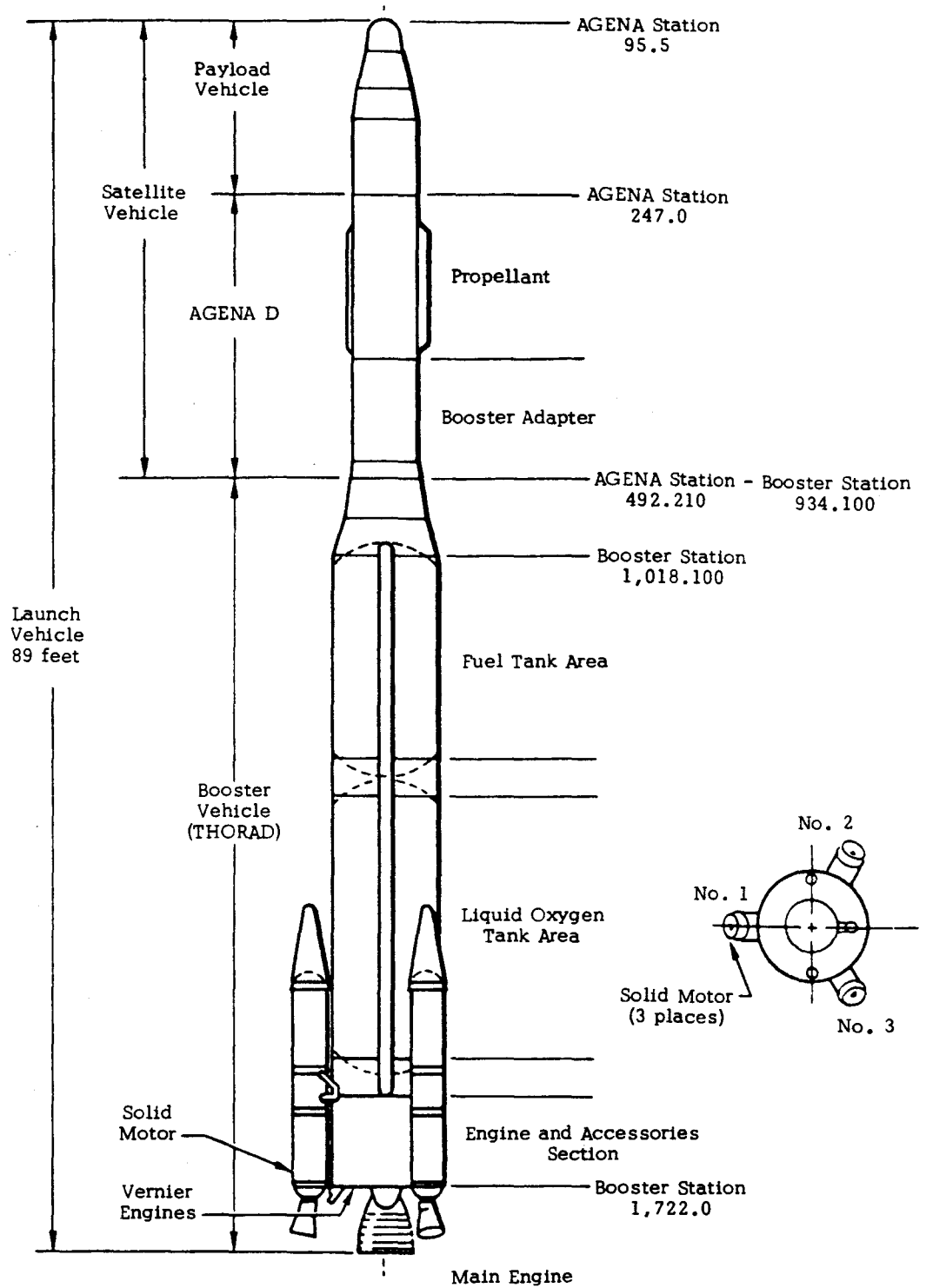

Figure 4-6

Handle via [REDACTED]
Controls Only

CORONA HISTORY
Volume V

Table 4-3 summarizes the weight budgets for the THORAD booster.

TABLE 4-3

THORAD BOOSTER WEIGHT BUDGET

<u>Item</u>	<u>Weight (pounds)</u>	<u>Total Weight (pounds)</u>
1. Weight Empty		
Propellants	145,926	7,797
Pressurization gas	798	
Solid motor boosters (3)	29,589	
2. Stage I Weight at Lift-off		
Less expendables	93,044	183,906
Less solid motor cases (3) (burn out at 40 seconds)	4,803	
3. Weight at Solid Motor Separation		
Less expendables (102 seconds)	76,557	86,059
4. Weight at Main Engine Cut-off		
Less expendables (218.4 seconds)	163	9,502
5. Weight at Vernier Engine Cut-off (228.9 seconds)		9,339

In summary, only three failures could be directly attributed to booster anomalies on the 145 launches conducted during the CORONA Program (February 1958 - May 1972). Mission 1113 was one of those three failures. Figure 4-7 is a series of photographs showing the remnants and investigation crew at the launch site. Figure 4-8 is a photograph of the debris collected from the launch area.

A LAUNCH CATASTROPHY - FEBRUARY 1971
(Mission 1113)



Investigation Crew



Film Remains



Impact Point
(Launch Complex In Background)



Recovery Capsules

Figure 4-7

COLLECTED DEBRIS FROM MISSION 1113 LAUNCH FAILURE



Figure 4-8

~~TOP SECRET~~

CORONA OPERATIONS

~~TOP SECRET~~

Handle via 
Controls (

SECTION V

CORONA OPERATIONS

COMMAND AND CONTROL SYSTEM

The CORONA command and control system was a simple and direct system which improved as the program developed and the requirements increased. Control of the vehicle and payload functions was accomplished in one of the two following ways:

A. Real time commands (RTC) issued over a remote tracking station (RTS) during satellite acquisitions furnished signals to a series of stepper switches (two to twenty contact positions). Each stepper switch was designed to adjust some vehicle or payload function.

B. Stored program commands (SPC) evolved from punches in 35mm tapes stored in the AGENA's H-timer. The H-timer would then transmit the signals for payload and vehicle functions as the satellite passed over the earth's surface. Vehicle operations personnel maintained the timer in synchronization with the orbit by directing command changes to slow or speed up the timer as required. Camera "on/off" commands were also provided by punches on the H-timer tapes. [REDACTED]

[REDACTED] provided a listing of the desired programmed camera operations on a rev-by-rev basis. The camera operations were punched and stored in the timer tape for selection on-orbit after matching such factors as geographic location, time of year, altitude, weather, etc. Figure 5-1 presents a diagram of the operational relationships of command, control, and telemetry between ground and the launch vehicle.

Early CORONA systems were limited to single camera program operations with the only option being to turn the camera "off." Later, two programs were possible, thus allowing some operational flexibility to better counteract unpredictable changes in weather and orbital flight. Program options were then increased to 10 by use of two 20 position stepper switches. Each of these programs could be divided into eight sections, each section could be called or remain in storage. The next camera program control improvement was the digital shift register (DSR) which was implemented on the J-3 system. The DSR system was controlled by a 32 word, five-bit register. The first bit controlled the "on/off" signals, the other four bits furnished addresses for the operations. A series of punches was inserted on the various tracks of the H-timer. These punches could be spaced up to five seconds apart (vehicle time) to correspond with the desired geographic location. Each of these punches could be used to control "on" or "off" as desired after matching the best weather/requirement option. Some 16 camera operations could be accomplished between remote tracking station acquisitions. DSR was able to provide a near real time on-orbit command capability. The DSR system had almost unlimited selection of camera operations, and still was within the same [REDACTED] on-orbit selection time frame as the earlier one and two camera program systems. It took approximately 45 minutes from selection

OPERATIONAL RELATIONSHIPS BETWEEN COMMAND, CONTROL, AND TELEMETRY

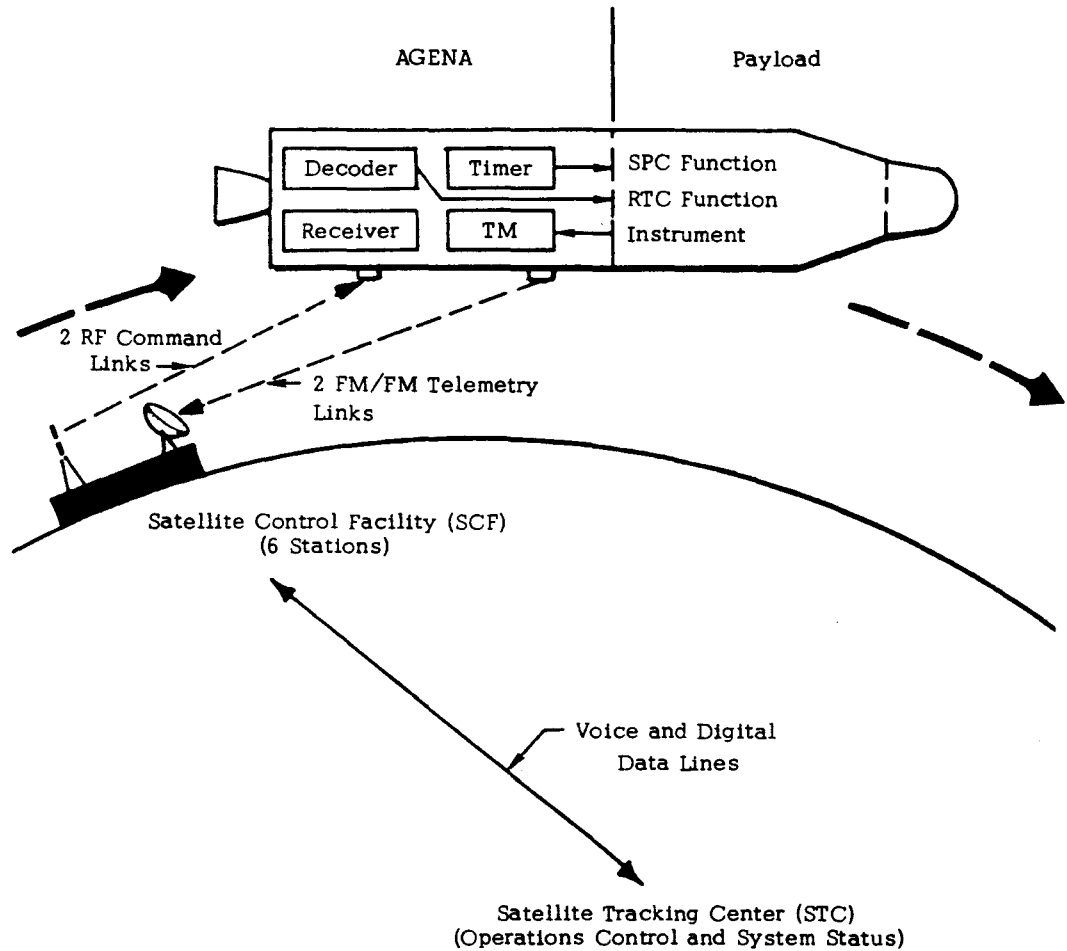

Figure 5-1

Handle with [REDACTED]
[REDACTED]
Controls Only

CORONA HISTORY
Volume V

of the operation to go from the STC to the SCF/RTS to the satellite. This relay time was maintained even as the command system grew more complex with the development of the J-3 Program. DSR loads were generated on both computer software and manually. Manual loads were developed for two reasons: (1) in cases where computer shutdown problems occurred, and (2) when they were more desirable from an SCF computer utilization standpoint. A backup camera command system similar to the early one camera program was available in the event of DSR problems. During the entire J-3 Program, this backup system was never required on-orbit, a tribute to the design, test, and operational reliability of the digital shift register system. Figure 5-2 is a flow diagram of the commanding support procedure utilized with DSR, while Figure 5-3 details the support software flow.

Because of the locations of the network of remote tracking stations and the orbits flown by CORONA, it was not possible to command the satellite on each revolution. Figure 5-4 presents a map which identifies a location of all RTS sites. Thus, it was necessary to load satellite vehicle and camera operation commands to cover a two, three, and sometimes four rev span. In order to be able to perform camera operations on one rev and not the next, the system utilized a small stepper switch intermix. The intermix or stepper switch was advanced one position by a punch in the H-timer tape which was matched to occur with the passing of the ascent mode of each orbital revolution. Thus, by proper position of the intermix, camera operations could be executed or negated. During the J-3 Program, the intermix capacity was increased to allow the camera programs to be divided into eight segments, thus allowing a better percentage chance of matching good weather with the requirement. This modification was highly successful as it resulted in approximately 70% clear weather photography over the area of interest.

DISIC camera operations were slaved to the main panoramic camera; however, an independent mode of operation was available. The camera program for independent operation was punched into the time tape. Therefore by sending a time command to the satellite, the independent mode could be selected by the setting of a stepper switch. The DISIC camera would automatically operate during the main panoramic camera operation and return to independent mode after the main camera stopped.

OPERATIONAL SOFTWARE

It was said, "When the weight of the paperwork equals that of the hardware, the bird is ready for launch." The words may be somewhat exaggerated, but one cannot deny the fact that a tremendous amount of planning, coordinating, and effort went into each operational CORONA system. Through the development of the direct communication method, and the high efficiency achieved by AP for program operation, software requirements were kept to a minimum. However, even at a minimum, software represented a sizable undertaking for the

DIGITAL SHIFT REGISTER COMMANDING SUPPORT

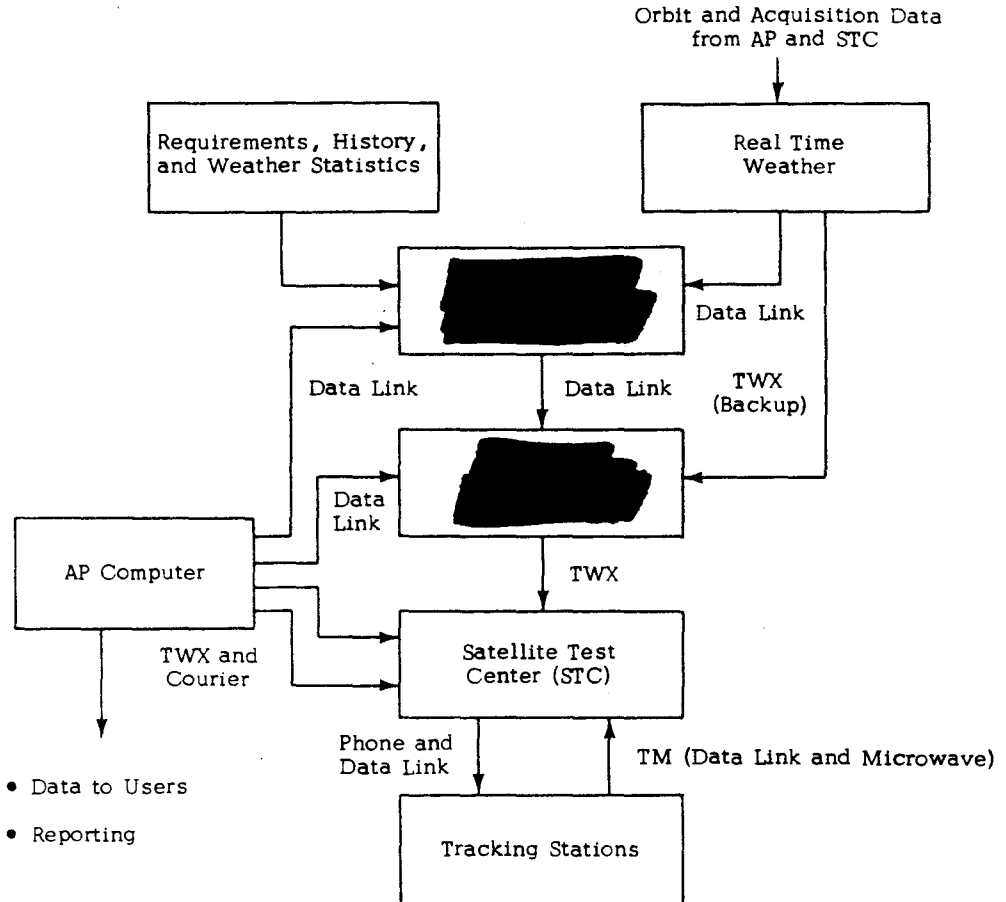

Figure 5-2

DIGITAL SHIFT REGISTER SUPPORT SOFTWARE

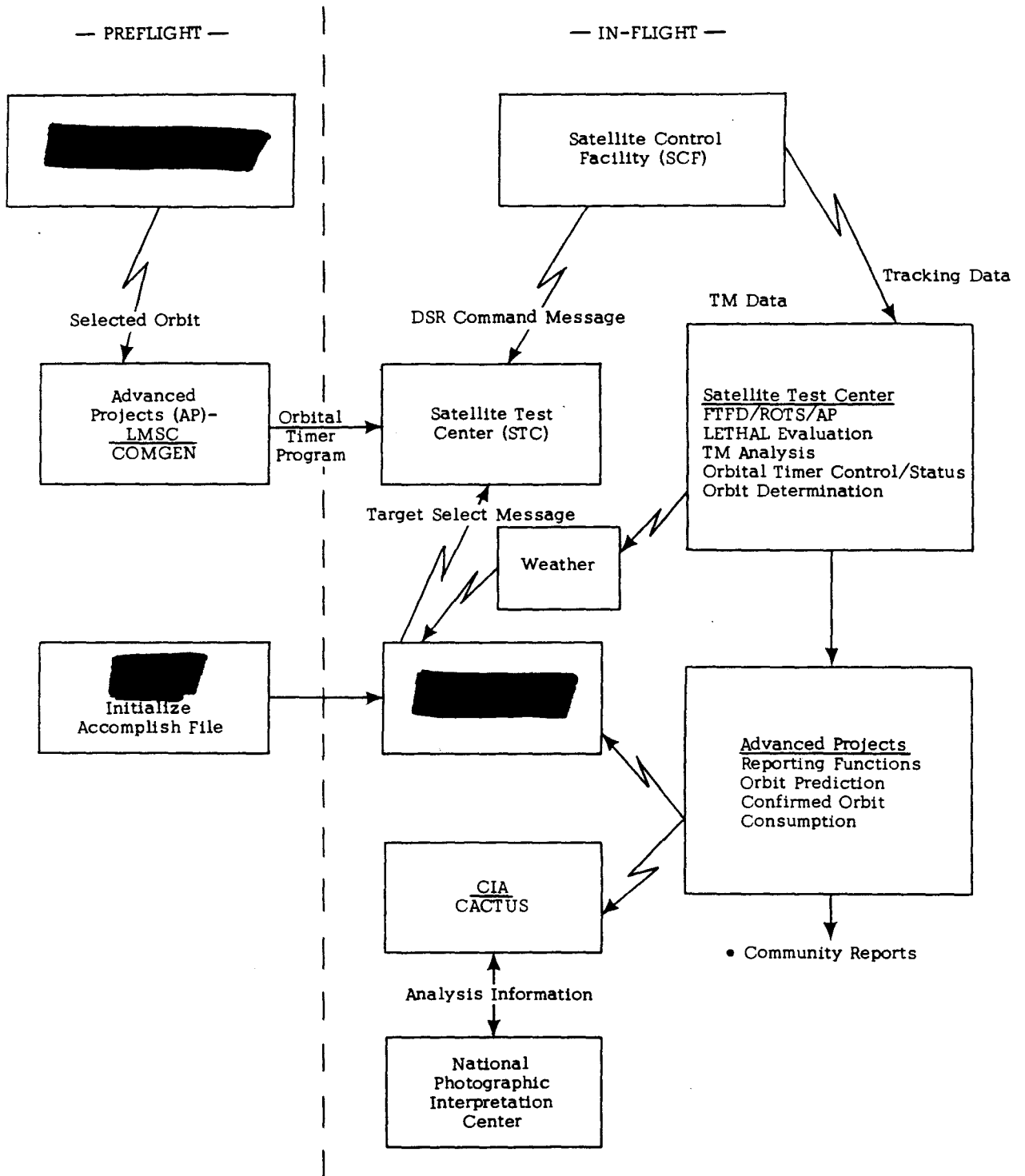

Figure 5-3

REMOTE TRACKING STATIONS (RTS)

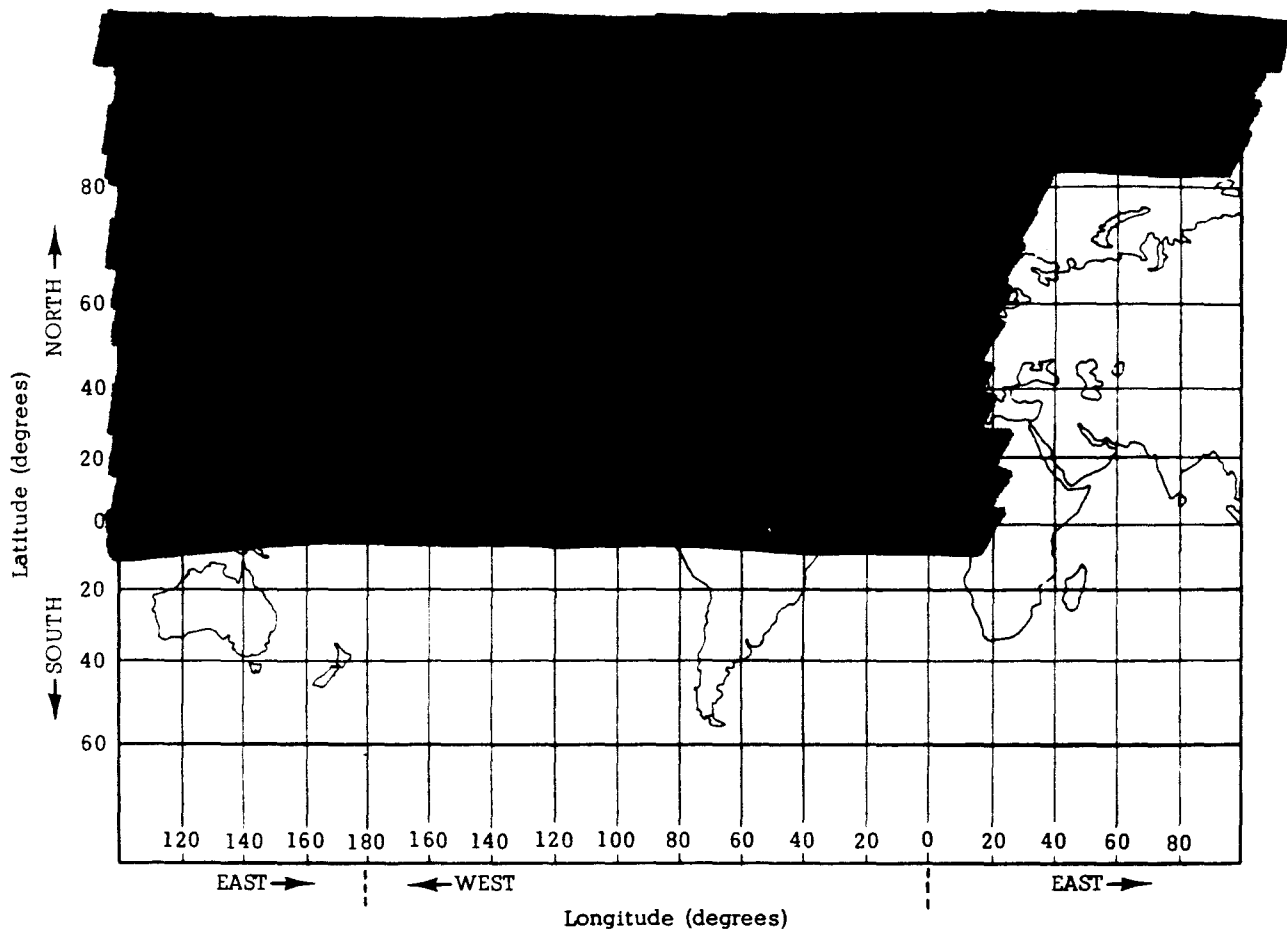

Figure 5-4

CORONA HISTORY
Volume V

complex operation of command and control of a reconnaissance satellite from hour-to-hour/day-to-day.

Once a mission was defined, many tasks had to be accomplished to provide for day-to-day system command and control operations. The compound effect of space related variables made it seemingly impossible to predict and calculate orbital conditions. In an effort to alleviate this problem, AP employed a battery of mechanical calculators and a team of dedicated operators who tirelessly calculated data for prelaunch planning and stored command programming. This laborious manual exercise lasted from the start of the CORONA Program to the beginning of 1962 when it was replaced by an IBM 1620 card system. The 1620 card system effectively supported the M Program operation for two years until it was upgraded by an IBM 7040 card/tape/printer system in 1964. The IBM 7040 was then used to perform data calculation tasks for the J system operation. The installation of the IBM 7040 was timely since the scope of command and control for the J system had increased over that of previous systems.

It was during the J system era that the use of intricate operational computer software programs began. Programs CACTUS and CALICO were developed in the latter part of 1965 to assist in target prediction and system on-orbit command generations. At the end of 1966, the state-of-the-art was again upgraded to an IBM 360 system with its enlarged data handling capacity and superior overall operational features. At this same time, the J-3 system was being developed to replace the J system. The more sophisticated J-3 system required more software to assist in all phases of its operations. Programs COMET, [REDACTED] and LETHAL were introduced to improve preflight orbit selection, orbit-by-orbit target programming, and DSR command generations. The development of these software programs enabled the J-3 systems to operate more efficiently and more cost-effectively. These software programs have also significantly contributed to the development and flexibility of other satellite reconnaissance programs.

Software preparations/designs could not have been as extensively utilized had it not been for the constant feedback of telemetry (TM) data from the orbiting system. There were two types of telemetered data (continuous and commutated) transmitted from the CORONA systems via the AGENA data link. Continuous data normally monitored the dynamic characteristics of the film and camera operation while commutated data monitored the status and thermal conditions of various subsystems and components. There were frequent and frustrating TM subsystem failures in the early CORONA systems. For example, it was an "open" secret among engineers that when commutators failed, a sharp, well-placed kick delivered on the skin of the structure adjacent to the unit would breathe new life to an otherwise dead motor. It was under this atmosphere of unknowns and unreliable components that the CORONA Program matured and developed. As complexity grew with each new camera system, more TM data was required, provided, and monitored. In the early days before data analysis programs, TM data was reduced manually. The J-3 configuration also included an in-flight tape recorder

CORONA HISTORY
Volume V

which was installed in each SRV. All dynamic and commutated data for each camera system operation was recorded. This feature made it possible for AP to resolve a number of mysterious anomalies/failures on-orbit. It also isolated a number of near catastrophic misses where corrective actions were taken and the mission product recovered. A good example was noting the control gas leak problem and the fact that the solar array failed to deploy on the last CORONA flight (1117). With this knowledge, it was decided to initiate recovery after only a six day operation. This recovery was successful and the film product saved.

ON-ORBIT OPERATIONS

The selection of camera operations was the responsibility of the Satellite Operations Center (SOC). AP provided the SOC with the remote tracking station (RTS) acquisition times and SOC decision times for a given rev or rev span. Forty-five minutes prior to the RTS acquisition the SOC would TWX their requirements to AP. The AP Duty Officer would process these requests by selecting the precise command changes to accomplish the task. This information was then phoned to the Satellite Tracking Center (STC) where the Field Force Test Director (FFTD) would take action through the Test Conductor to have the RTS issue these commands during the satellite vehicle acquisition at that station. Lockheed TM personnel would monitor the Satellite Control Facility (SCF) telemetry and other data to ensure that the payload and AGENA vehicle systems were operating properly. Once or twice daily, payload engineering operations could be taken while the satellite vehicle was within the acquisition range of the [REDACTED] remote tracking station. Camera operations data, temperatures, and other TM information could be obtained from the engineering operation by means of a microwave link between the STC and the [REDACTED].

Figure 5-5 presents a flow diagram of the orbit selection procedure and a listing of the capability limits of a J-3 payload on-orbit. Figure 5-6 shows a table depicting the interactions involved in orbit selection. Figure 5-7 displays the relationships of the orbital inclination angle. Figure 5-8 is a graph illustrating the orbital radius coverage. Figure 5-9 is a map showing the coverage pattern of an 8.5 day synchronous orbiting vehicle at 81.5 degrees inclination. Figure 5-10 lists and illustrates the operations of the drag makeup unit (DMU).

As the complexity of the CORONA Program increased and the command system improved, it became desirable for the Payload Duty Officer to physically relocate to the STC for the on-orbit phase. As a result of this move, operations became more formal. Selection of payload operations remained with the SOC, but the options available to them became greater. The addition of the drag makeup unit rockets to the J-3 system also required more mission on-orbit support. Mission support remained at AP but was now required to be supplied to both the STC and the SOC. The on-orbit support provided by the Integrating Contractor throughout the life of CORONA contributed significantly to the success of this program.

ORBIT SELECTION AND ON-ORBIT PAYLOAD CAPABILITIES

— Orbit Selection Procedure —

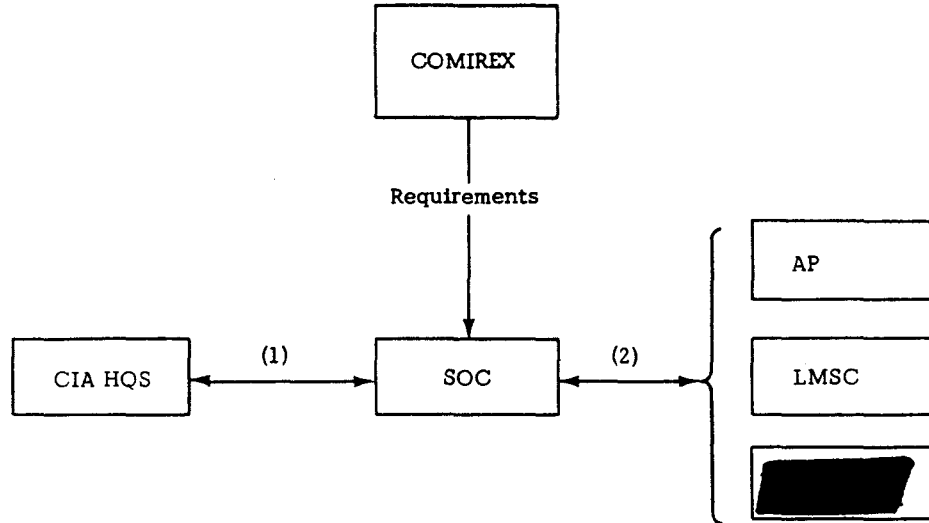

- NOTES: (1) COMET Computer Program uses target requirements and weather history to evaluate orbits for coverage and utility.
 (2) Establish compatible schedule and select orbit commensurate with system constraints.

— On-Orbit J-3 Payload Capability Limits —

Altitude	80 to 200 nautical miles
Cycle Period	1.5 to 4.2 sec/cyc
Period	88 to 91.5 minutes
Inclination	60 to 110 degrees
Beta Angle	+65 to -65 degrees
Perigee Altitude	80 to 110 nautical miles

Figure 5-5

Handle via [REDACTED]
 Controls Only

ORBITAL SELECTION INTERACTIONS

	Mission Life	Launch Time	Perigee Location	Perigee Height	Orbit Period	Inclination
Coverage Pattern	Pattern repetition				Track spacing	North limit
Mean Photo Altitude			Keep lowest profile over USSR/China			
Booster Performance	Battery and DMU weight		Burn time and injection angle	DMU "topping"	Injection limit	14 lbs per degree
Drag Makeup Requirement	Solar activity		12 DMUs; limited control; cross purposes			
Solar Illumination	Total beta excursion	Early afternoon				Beta rotation rate
Perigee Rotation	Total excursion		20°N to 60°N latitude			4°N per day
Recovery Limits		Daylight recovery	Re-entry heating			
Camera Cycle Rate			V/h delay	V/h 1/2 cycle level	V/h curve shape	

Figure 5-6

ORBITAL INCLINATION ANGLE

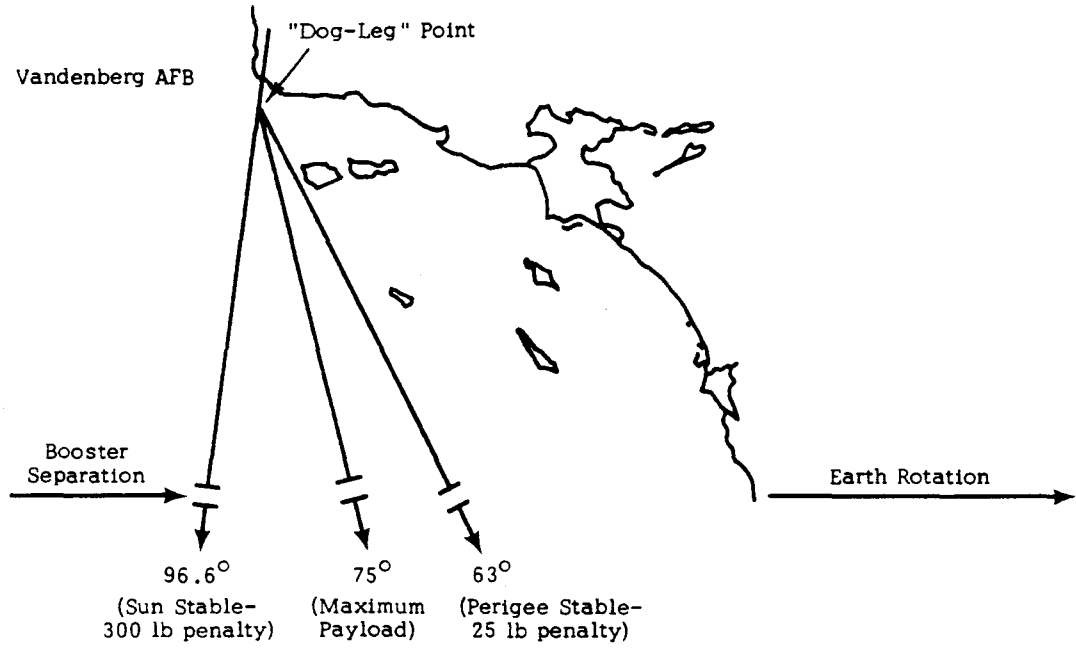

- NOTES: 1. Usual range is 75° to 85°.
2. In this range each degree costs approximately 14 lbs and perigee rotates approximately 4°N per day.

Figure 5-7

ON-ORBIT RADIUS PROFILES
(8.5 Day Synchronous Orbit at 81.5° Inclination)

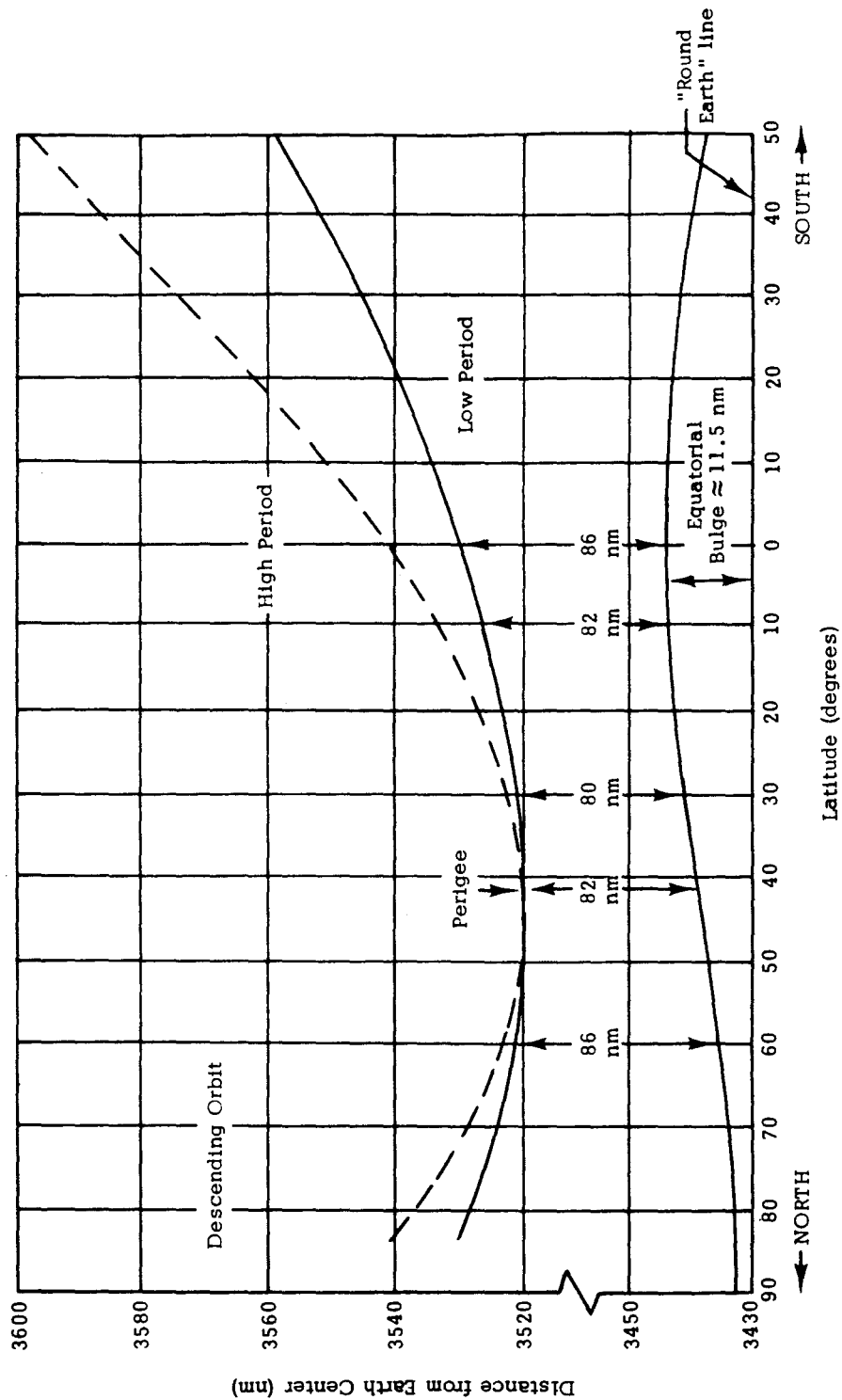
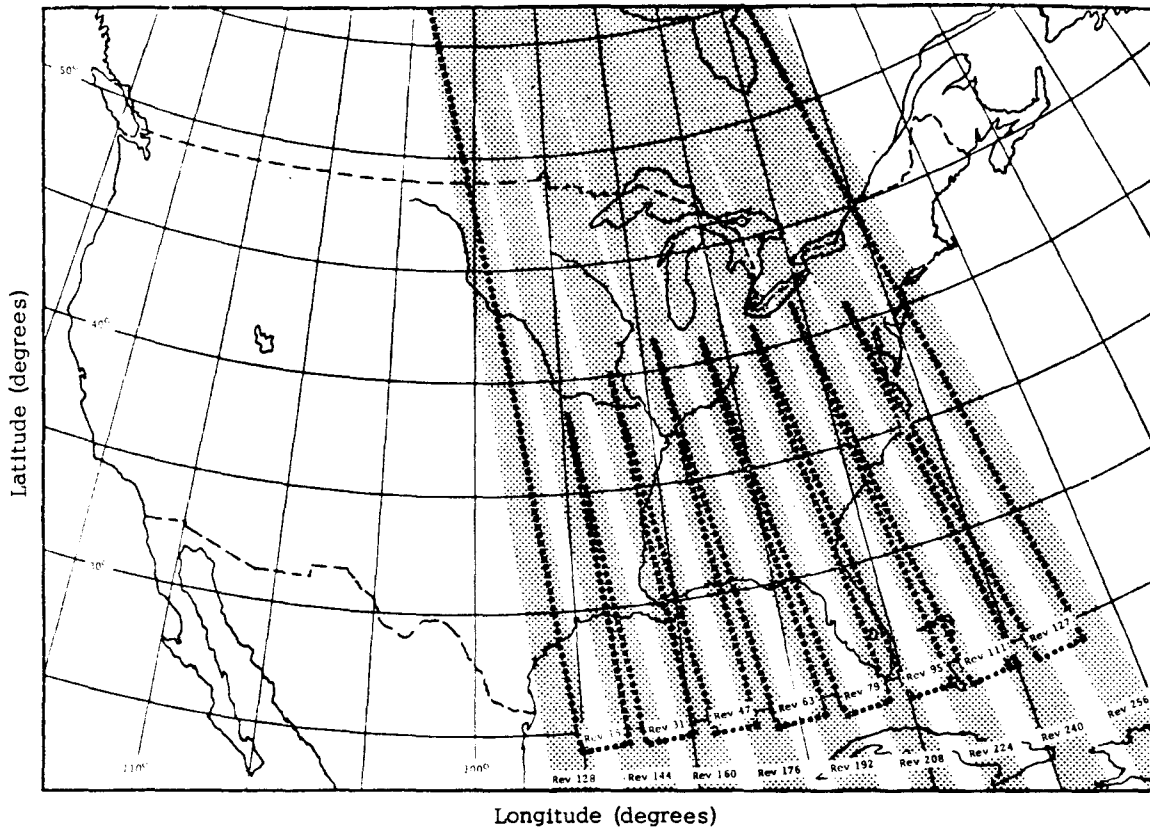

Figure 5-8

ON-ORBIT COVERAGE PATTERN
(8.5 Day Synchronous Orbit at 81.5° Inclination)



Day 1	Rev 15	Day 8	Rev 128
2	31	9	144
3	47	10	160
4	63	11	176
5	79	12	192
6	95	13	208
7	111	14	224
8	127	15	240
		16	256

Figure 5-9

DRAG MAKEUP UNIT (DMU) OPERATIONS

—Operations Objectives —

- Maintain orbit life in excess of vehicle life.
- Attain and maintain desired orbit synchronism; i.e., attain desired ground track patterns and maintain desired altitude and location of perigee.
- Attain minimum possible photographic altitude.
- Maintain orbit profile within payload system capability:
 - V/h control
 - Recovery sequence
 - Exposure control

—Historical Example of J-3 DMU On-Orbit Operation —

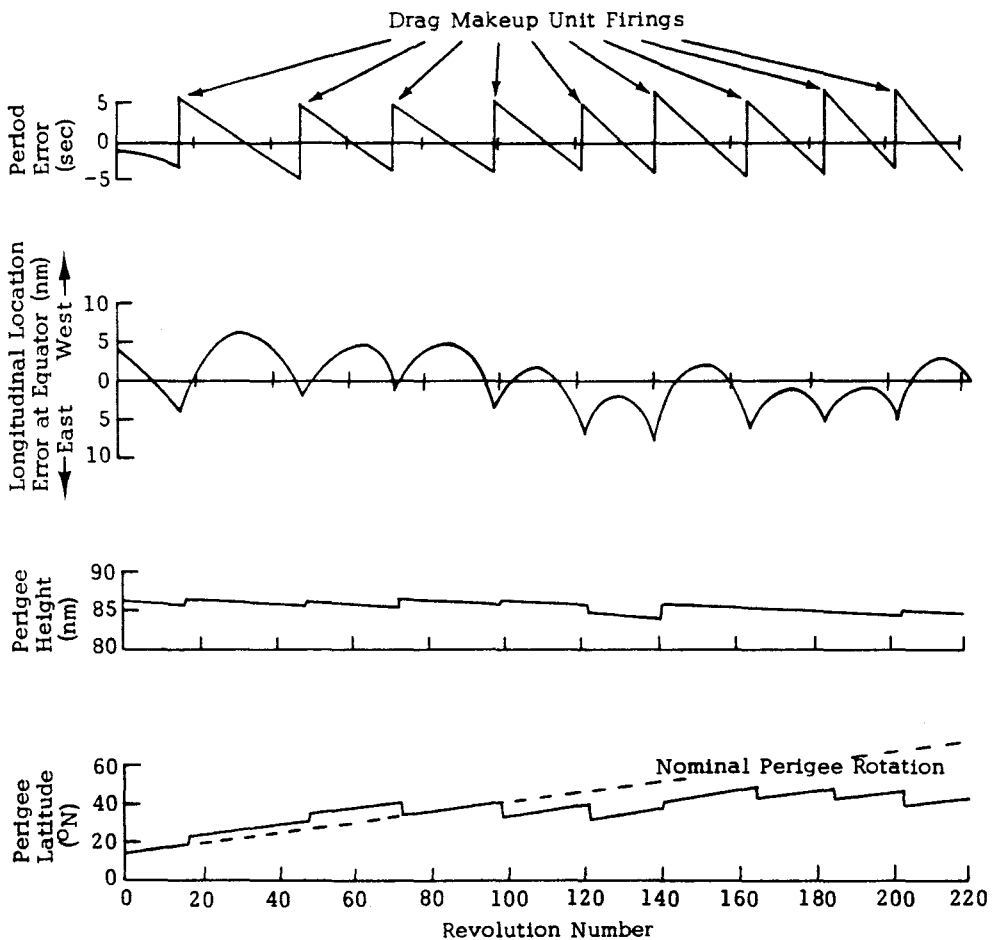

Figure 5-10

Handle via [redacted]
Controls Only